

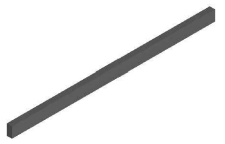

<p>Componenti Components</p>		<p>Seduta (A) Seat (A)</p>		<p>Trave x1 (B) Beam x1 (B)</p>		<p>Staffa a U (C) "U" shaped bracket (C)</p>		<p>Gamba per panca x2 (D) Leg for bench x2 (D)</p>
<p>SERIE SNACK SNACK SERIES</p>								

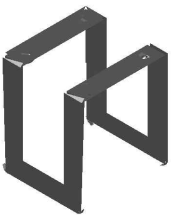

1) Estrarre la seduta (A) dalla scatola
1) Extract the seat (A) from the box

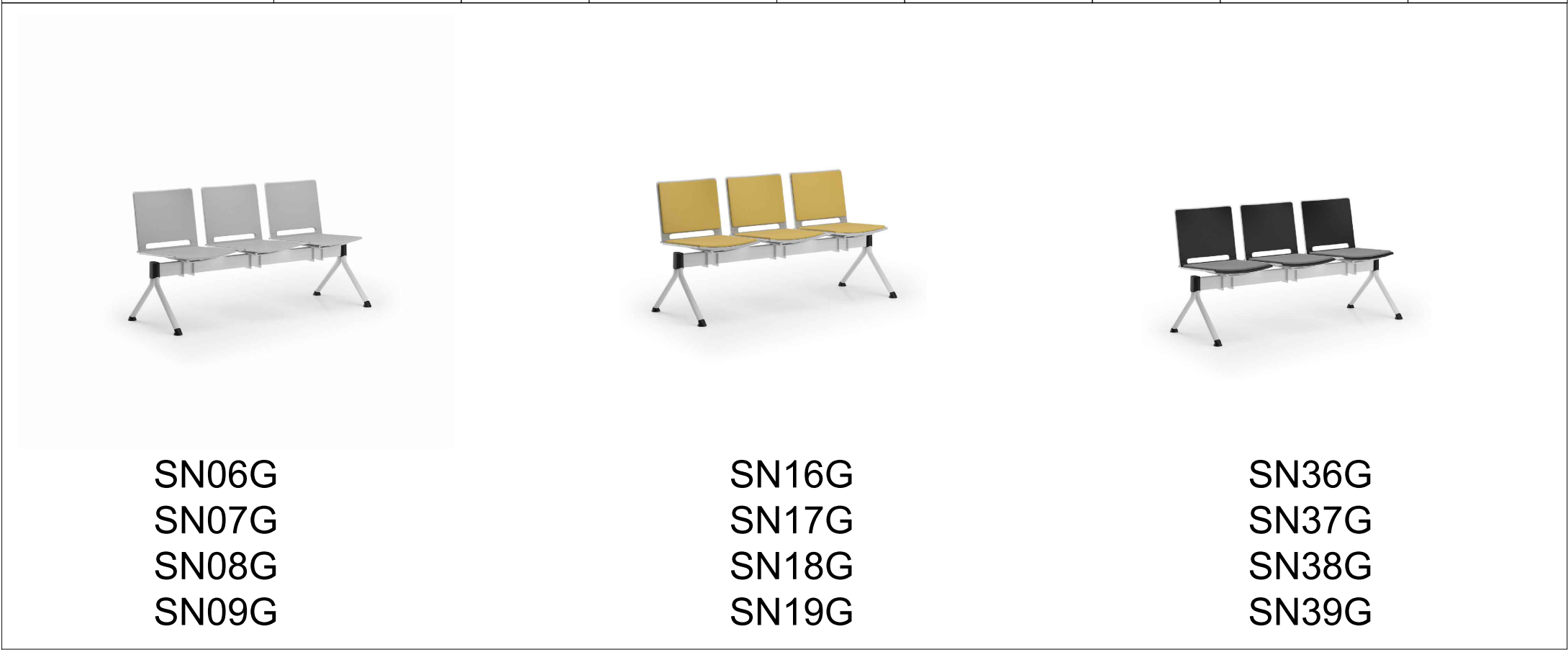

2) Estrarre le gambe (D) dalla scatola
2) Extract the legs (D) from the box



3) Estrarre la trave (B) dalla scatola
3) Extract the beam (B) from the box

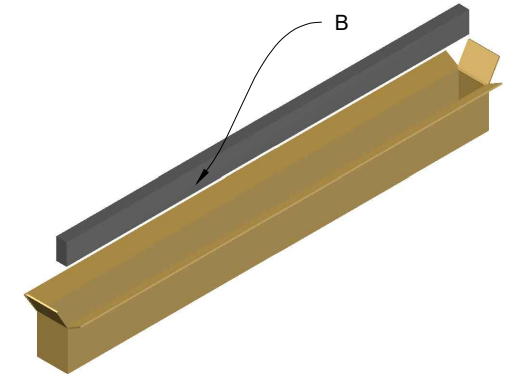

4) Inserire la trave (B) nelle gambe (D).
4) Insert the beam (B) in the legs (D)

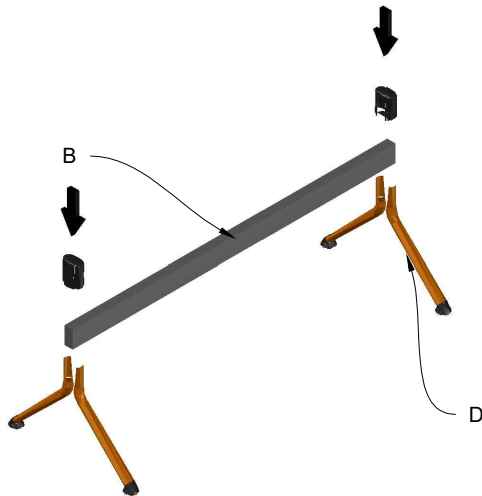

5) Inserire la staffa a U (C) indicando la posizione delle sedute nella trave (B)
5) Insert the "U" shaped bracket (C) to indicate the seat positions on the beam (B)

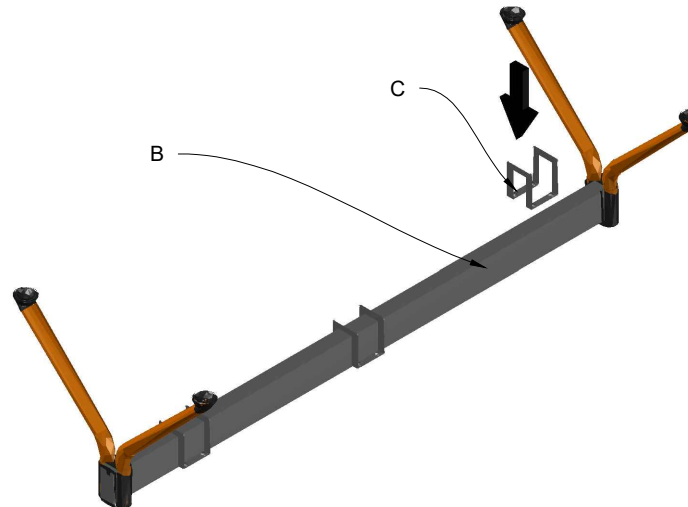

6) Posizionare la seduta (A) sopra la staffa a U (C) e fissarla con in bulloni una volta scelta la posizione finale.
6) Position the seat (A) above the "U" shaped bracket (C) and fasten it by means of the bolts when the final position has been chosen

