

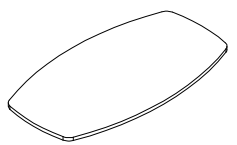





Ferramenta Hardware	Componenti Components							
Chiave esagonale Hexagonal key	n°1		Piano (A) Top (A)		Gambone (B) Structural leg (B)		Piastra (C) Plate (C)	
	n°8							
	n°8							
	n°8							
	n°8							

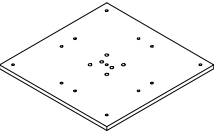
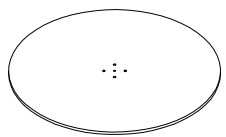
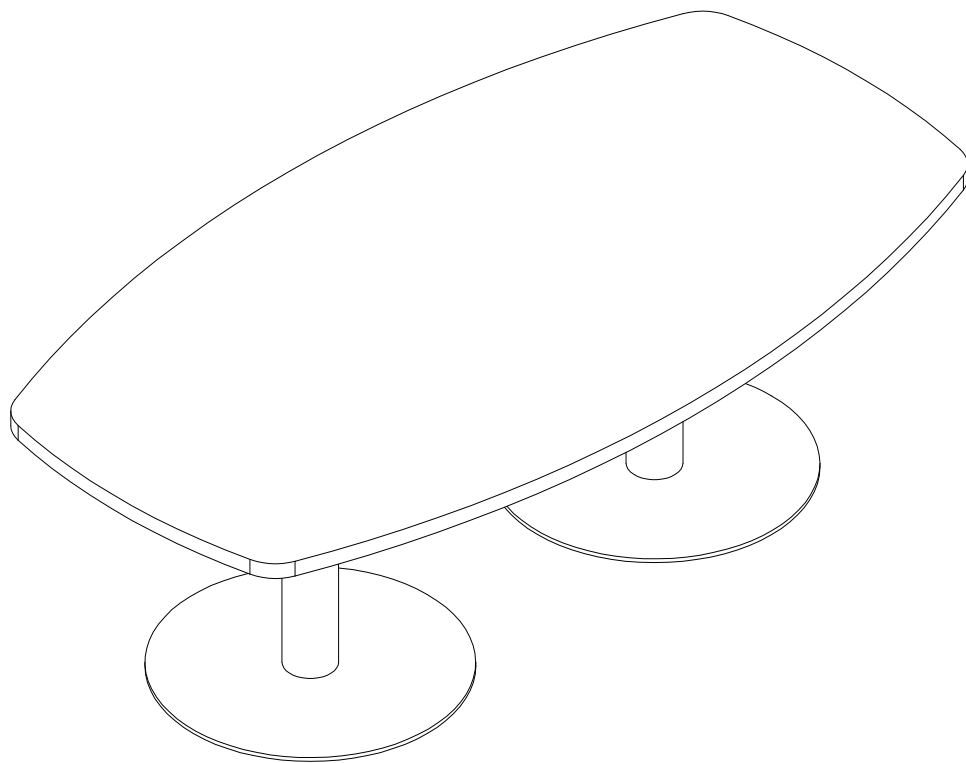
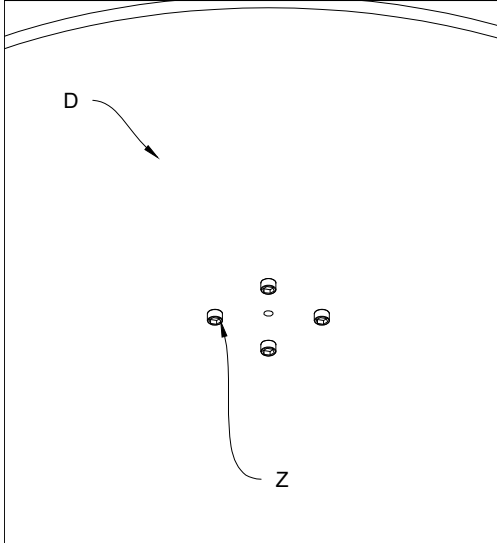

Fig.1 Fissare i bulloni (Z) nella base (D)

Fig.1 Fasten the bolts (Z) to the base (D)



1) Posizionare il gambone (B) sopra la base (D)

1) Position the structural leg (B) on top of the base (D)

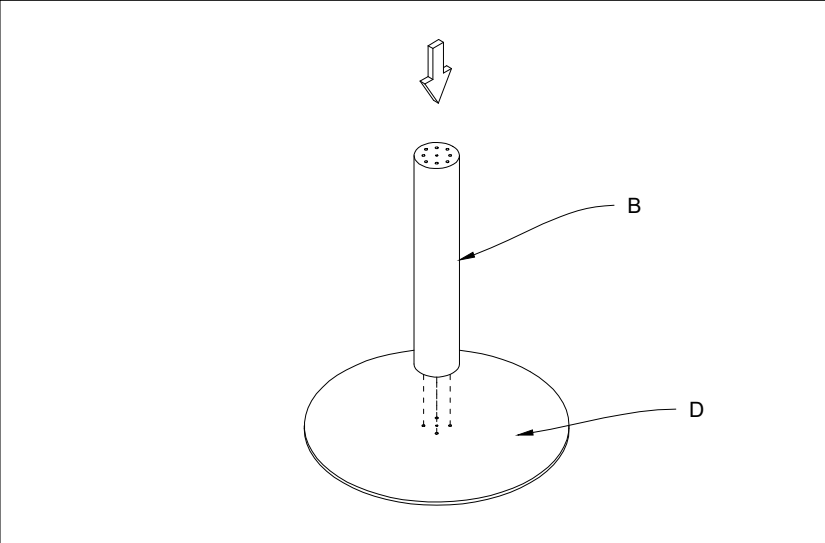

2) Unire il gambone (B) e la base (D) con i bulloni (Z)

2) Fasten the structural leg (B) to the base (D) by means of the bolts (Z)

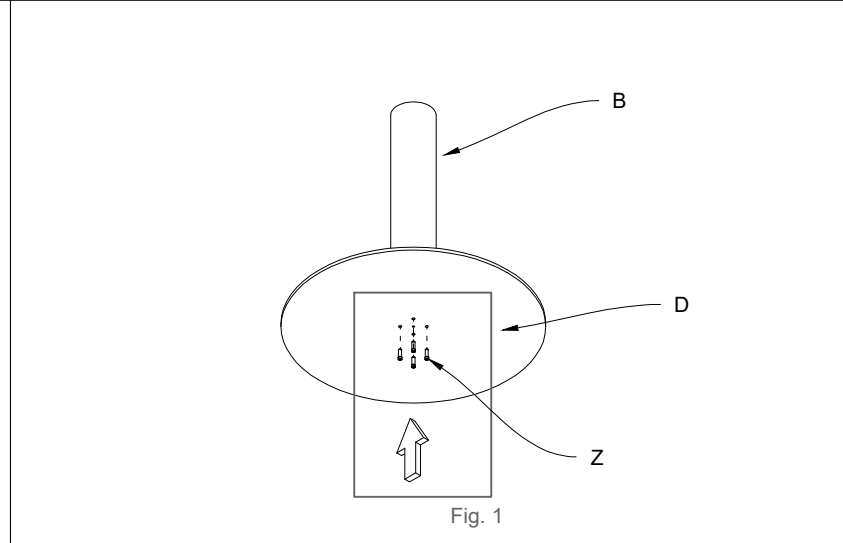
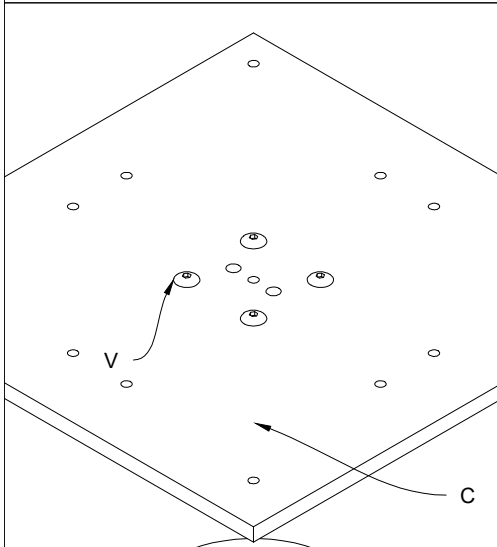

Fig.2 Fissare i bulloni (V) nella piastra (C)

Fig.2 Insert the bolts (V) into the plate (C)



3) Posizionare la piastra (C) sopra il gambone (B) con i bulloni (V)

3) Position the plate (C) on top of the structural leg (B) in function of the bolts (V)

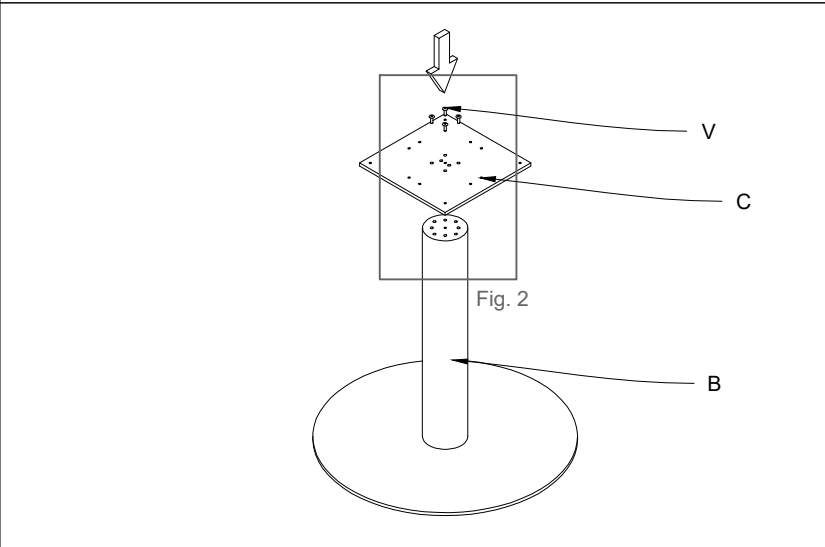

4) Posizionare il piano (A) sopra la struttura.

4) Position the top (A) on top of the structure.

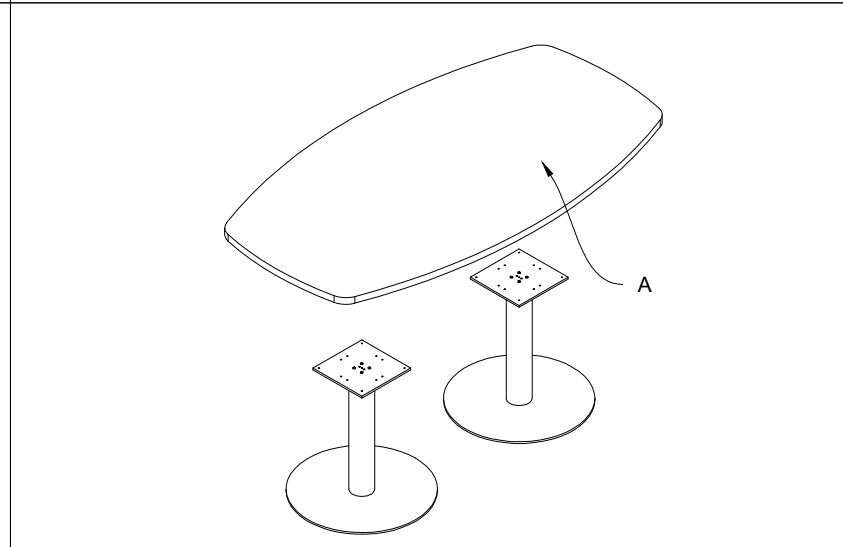

Fig.1 Fissare i bulloni (U) al piano (A)

Fig.1 Insert the bolts (U) in the top (A)

5) Unire la struttura e il piano (A) tramite i bulloni (U)

5) Unite the structure and top (A) by means of the bolts (U)

