







Ferramenta Hardware	Componenti Components		Piano (A) Top (A)	Fianco DX (B) R side (B)	Fianco SX (C) L side (C)	Traversa (D) Cross panel (D)
Spina in legno 8x30 (P) 	Wooden pin 8x30 (P) n°6					
Piedini regolabili diam.=35 (Q) 	Adjustable feet diam.=35 (Q) n°4					
Grano 8x12 (R) 	Threaded screw 8x12 (R) n°4					
Barilotto 14x17.5 (S) 	Barrel 14x17.5 (S) n°4					
Barilotto 14x14 (T) 	Barrel 14x14 (T) n°5					
Tirante 7x33.5 (U) 	Tie-rod 7x33.5 (U) n°9					
Grano 8x8 (V) 	Threaded screw 8x8 (V) n°5					
						

Fig.1 Posizionare spine (P), barilotti(S),tiranti(U) nei fianchi(B e C)
 Fig.1 Position the pins (P), barrels (S) and tie-rods (U) in the sides (B and C)

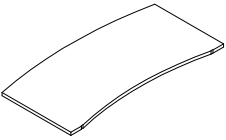
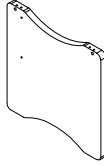
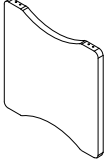
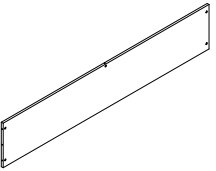

1) Posizionare le spine (P), i barilotti (S), i tiranti (U) e piedini (Q) nei fianchi (B e C).
 1) Position the pins (P), barrels (S), tie-rods (U) and feet (Q) in the sides (B and C)

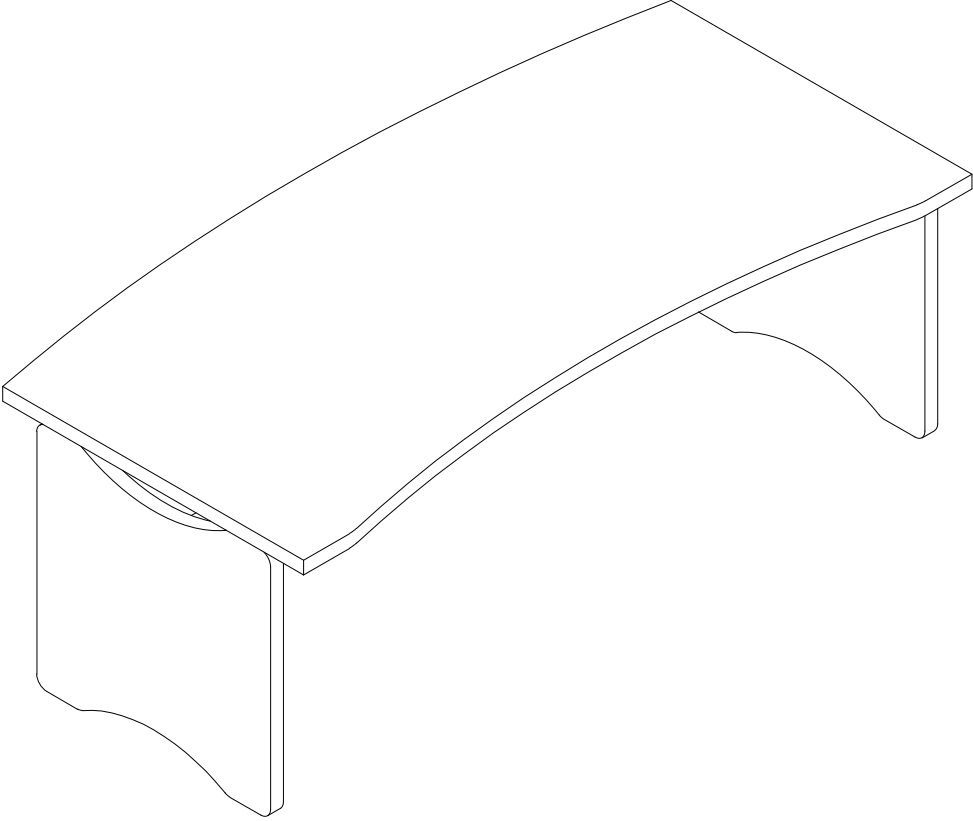
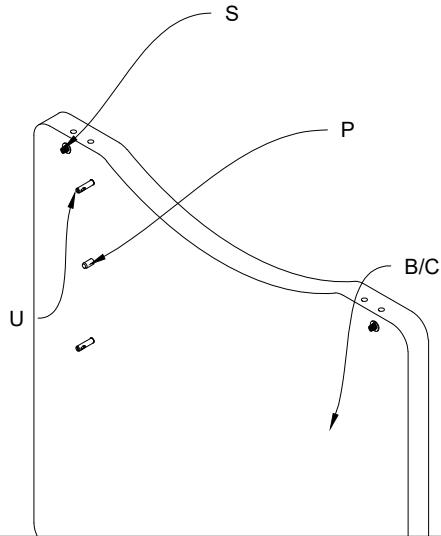
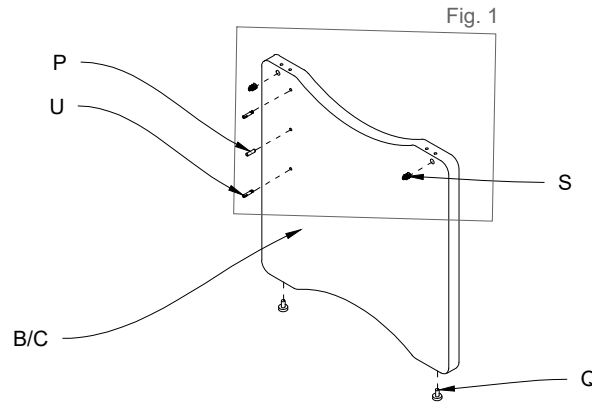

2) Posizionare i barilotti (T) nella traversa (D).
 2) Position the barrels (T) in the cross panel (D)

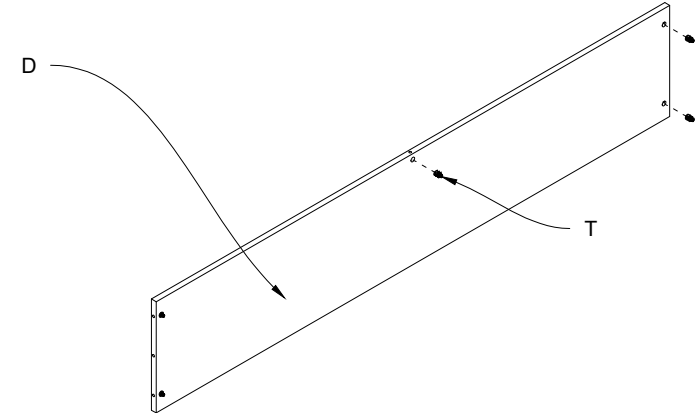
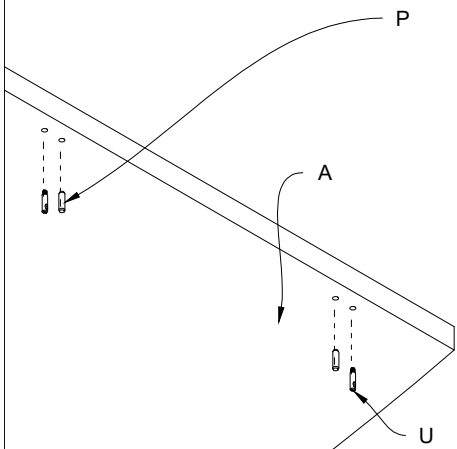
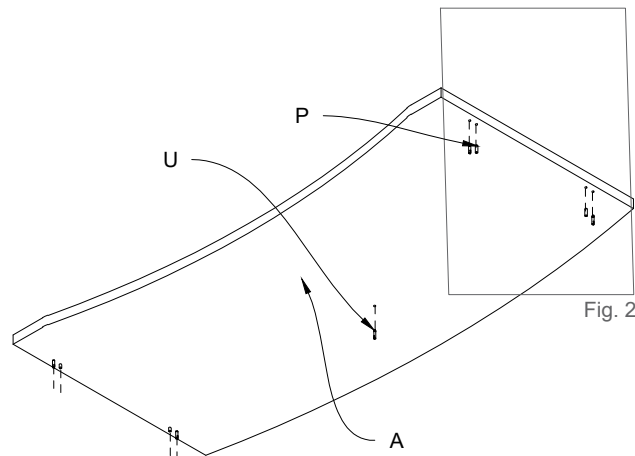

Fig.2 Posizionare spine (P) e tiranti(U) nel piano (A)
 Fig.2 Position the pins (P) and tie-rods (U) in the top (A)



3) Posizionare le spine (P), e i tiranti(T) nel piano (A).
 3) Position the pins (P) and tie-rods (U) in the top (A)



4) Unire i fianchi (B e C) alla traversa (D) tramite le spine (P) e i tiranti (U)
 4) Unite the sides (B and C) to the cross panel (D) by means of the pins (P) and tie-rods(U)

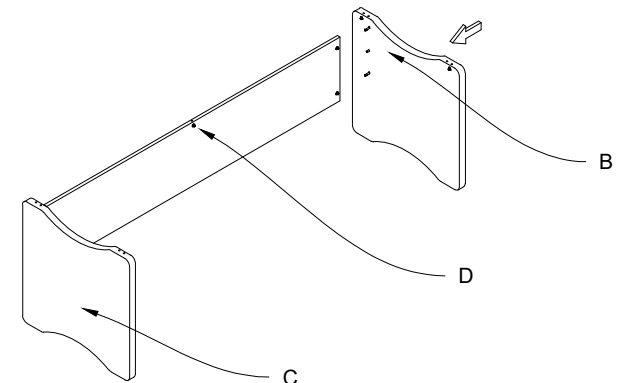
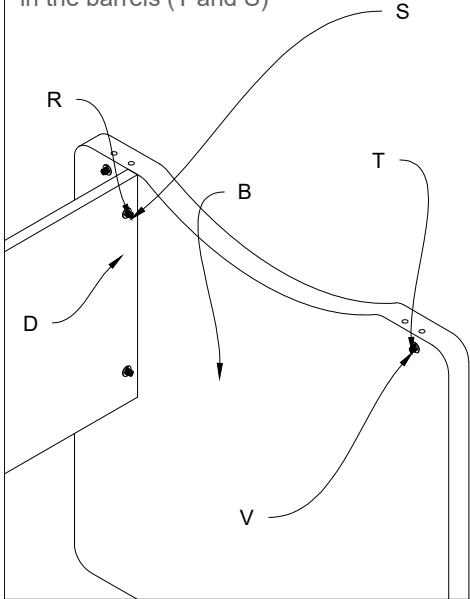
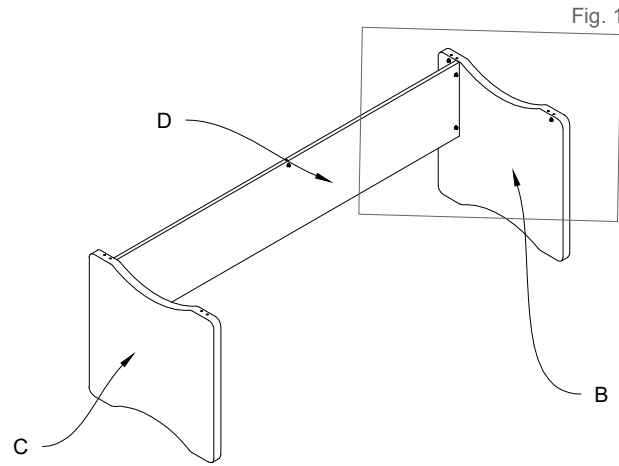

Fig.1 Serraggio grani (V e R) nei barilotti (T e S)
Fig.1 Tighten the threaded screws (V and R) in the barrels (T and S)



5) Serraggio grani (V e R) nei barilotti(T e S)
5) Tighten the threaded screws (V and R) in the barrels (T and S)



6) Posizionare il Piano (A), sopra la struttura e agganciarlo tramite le spine (P) e i tiranti (U)
6) Position the top (A) on top of structure and fasten it by means of the pins (P) and tie-rods (U)

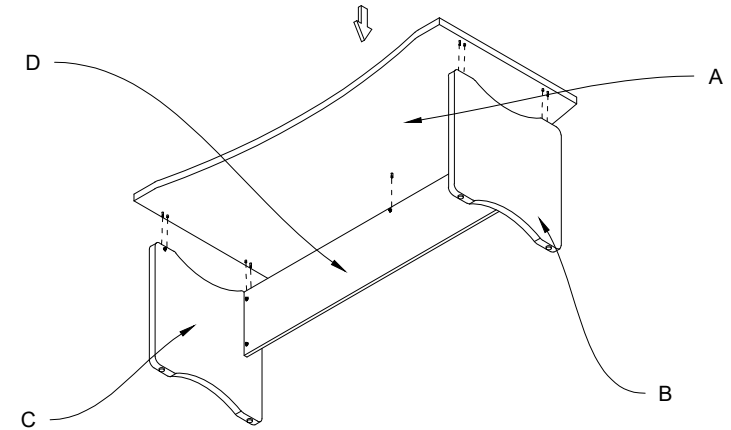
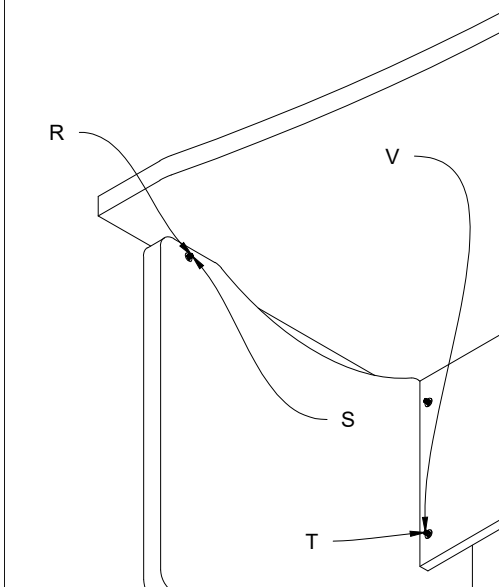

Fig.2 Serraggio grani (V e R) nei barilotti (T e S)
Fig.2 Tighten the threaded screws (V and R) in the barrels (T and S)



7) Serraggio grani (V e R) nei barilotti(T e S)
7) Tighten the threaded screws (V and R) in the barrels (T and S)

