

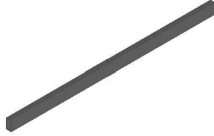





Schema di montaggio

Assembly diagram

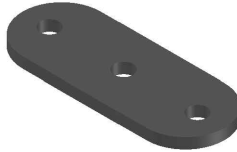
<p>Componenti Components</p>		<p>Seduta (A) Seat (A)</p>		<p>Trave x1 (B) Beam x1 (B)</p>		<p>Staffa a U (C) "U" shaped bracket (C)</p>		<p>Gamba per panca x2 (D) Leg for bench x2 (D)</p>
<p>SERIE LOOK LOOK SERIES</p>		<p>Staffe per unione travi (E) Union plate for beams (E)</p>		<p>Bracciolo (F) Armrest (F)</p>		<p>Tavoletta scrittoio (G) Writing tablet (G)</p>		<p>Snodo antipanico (H) Anti-panic joint (H)</p>



LP144G-LP144N-LP145G-LP145N-LP146G-LP146N-LP147G-LP147N-LP148G-LP148N-LP149G-LP149N
 LP150G-LP150N-LP151G-LP151N-LP152G-LP152N-LP153G-LP153N-LP154G-LP154N-LP155G-LP155N
 LR144G-LR144N-LR145G-LR145N-LR146G-LR146N-LR147G-LR147N-LR148G-LR148N-LR149G-LR149N
 LR150G-LR150N-LR151G-LR151N-LR152G-LR152N-LR153G-LR153N-LR154G-LR154N-LR155G-LR155N
 LF144G-LF144N-LF145G-LF145N-LF146G-LF146N-LF147G-LF147N-LF148G-LF148N-LF149G-LF149N
 LF150G-LF150N-LF151G-LF151N-LF152G-LF152N-LF153G-LF153N-LF154G-LF154N-LF155G-LF155N
 L144G-L144N-L145G-L145N-L146G-L146N-L147G-L147N-L148G-L148N-L149G-L149N-L150G-L150N-L151G
 L151N-L152G-L152N-L153G-L153N-L154G-L154N-L155G-L155N

1) Uscire tutti gli elementi dalle scatole.

1) Extract all elements from the boxes

2) Uscire tutti gli elementi dalle scatole.

2) Extract all elements from the boxes

3) Uscire tutti gli elementi dalle scatole.

3) Extract all elements from the boxes

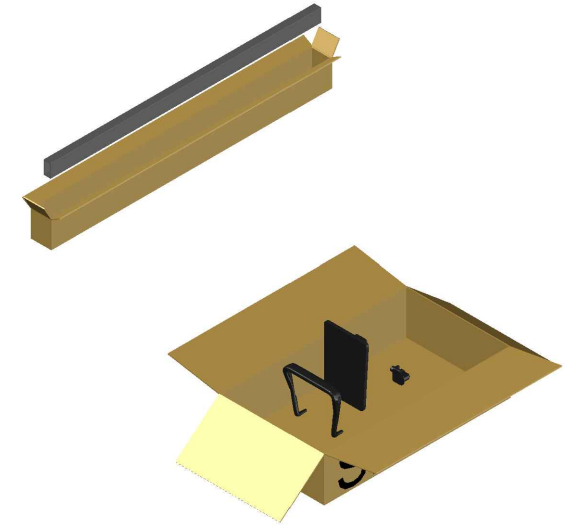

4) Inserire la trave (B) nelle gambe (D).

4) Insert the beam (B) in the legs (D)

5) Inserire la staffa a U (C) indicando la posizione delle sedute nella trave (B)

5) Insert the "U" shaped bracket (C) to indicate the seat positions on the beam (B)

6) Unire lo snodo antipánico (H) alla tavoletta (G).

6) Unite the anti-panic joint (H) to the writing tablet (G)

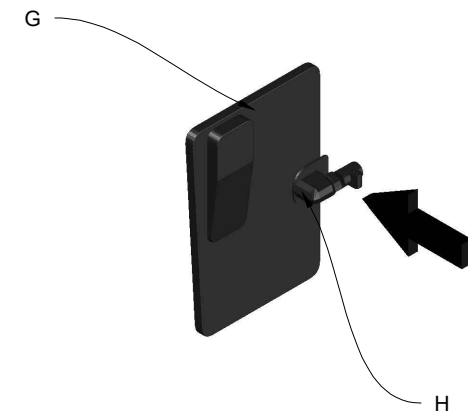
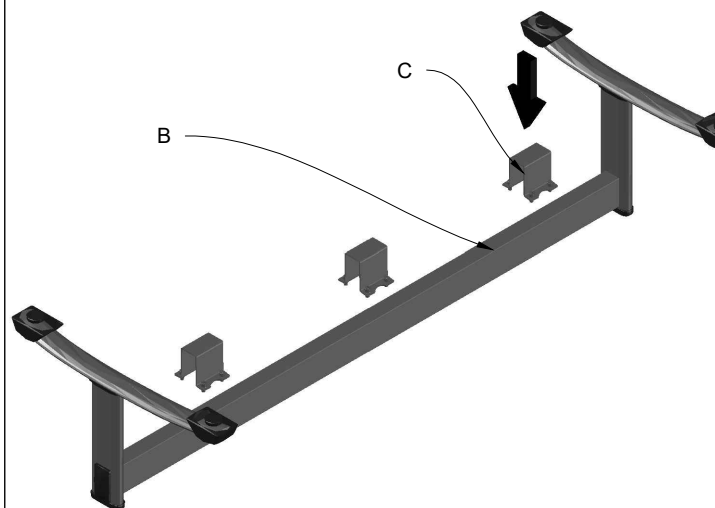
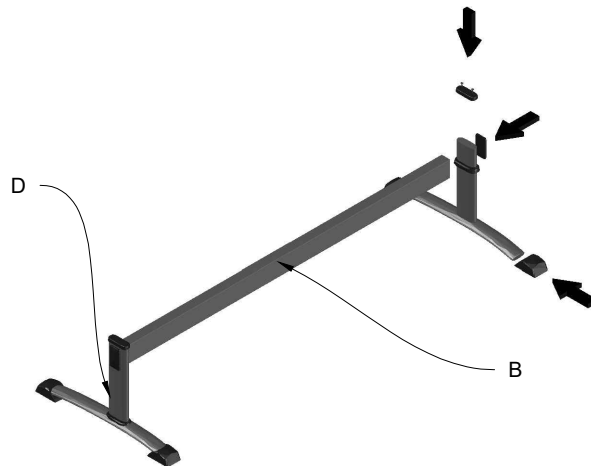

7) Inserire la tavoletta (G) con lo snodo (H) nel bracciolo (F).
7) Insert the writing tablet (G) and joint (H) in the armrest (F)

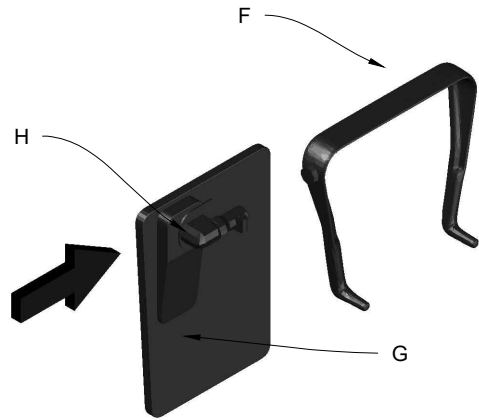

8) Inserire il bracciolo (F) nella seduta (A).
8) Insert the armrest (F) in the chair (A)

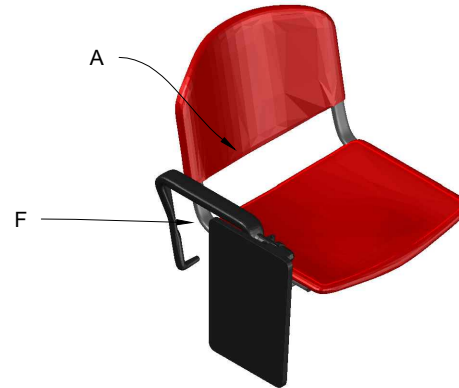

9) Posizionare la seduta (A) sopra la staffa a U (C) e fissarla con in bulloni una volta scelta la posizione finale.
9) Position the seat (A) above the "U" shaped bracket (C) and fasten it by means of the bolts when the final position has been chosen

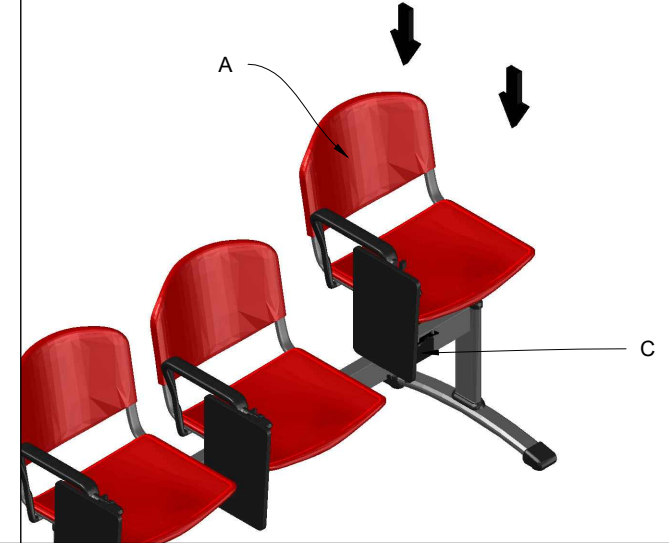

10) Per unire due panche, utilizzare una gamba (D) come punto di aggancio tra le due travi (B).
10) Use one leg (D) as a coupling point between two beams (B) to unite two benches

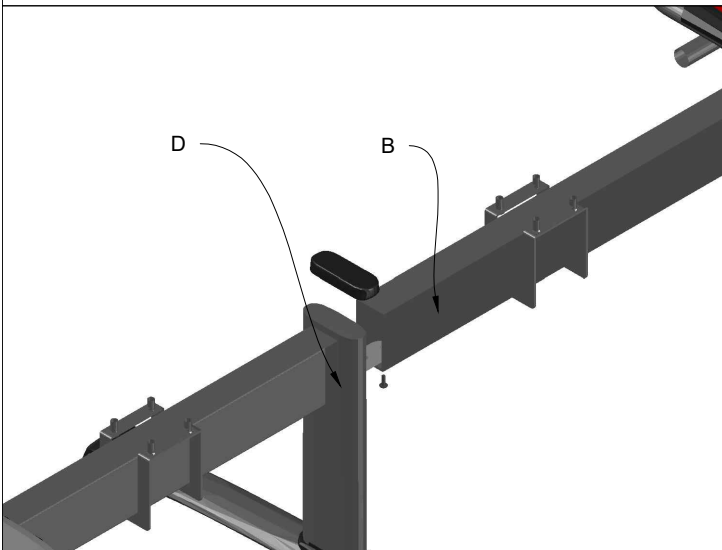

11) Unire le due travi (B) tramite una staffa di unione (E) inserendola all'interno e serrarla con delle viti.
11) Insert the union plate (E) inside the beam, tighten the screws to unite two beams (B)

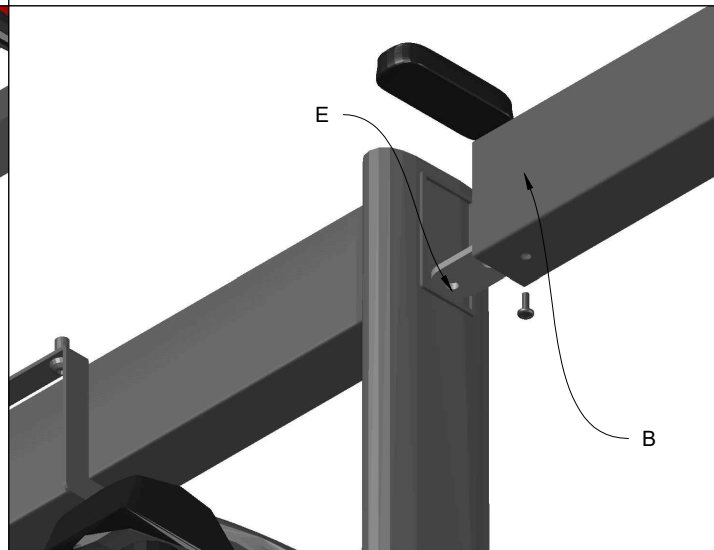

12) Posizionare le sedute (A) sopra la staffa a U (C) e fissarla con in bulloni una volta scelta la posizione finale.
12) Position the seat (A) above the "U" shaped bracket (C) and fasten it by means of the bolts when the final position has been chosen

