

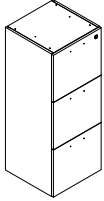

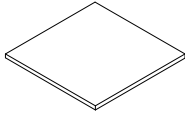



Ferramenta Hardware	Componenti Components		Classificatore (A) Filing cabinet (A)		Top (B) Finished top (B)				
Chiave esagonale Hexagonal key 	n°1								
Viti 4x30 (T) Screws 4x30 (T) 	n°4								
Piedino (U) Foot (U) 	n°4								
Bullone 4x12 (V) Bolt 4x12 (V) 	n°6								
Maniglie (Z) Handles (Z) 	n°3								

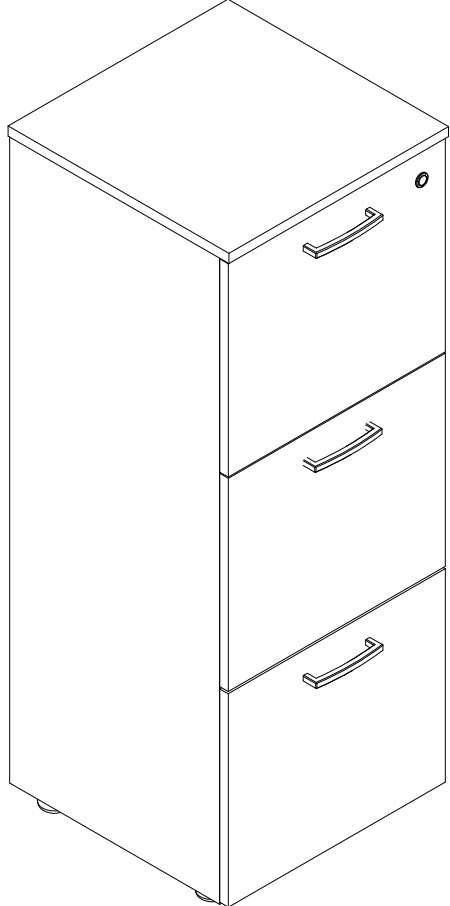
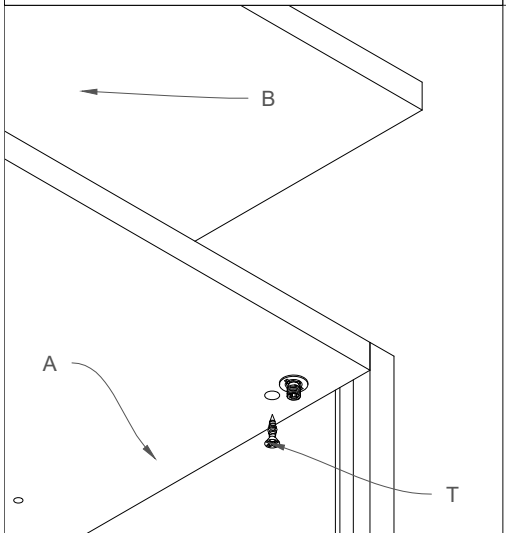
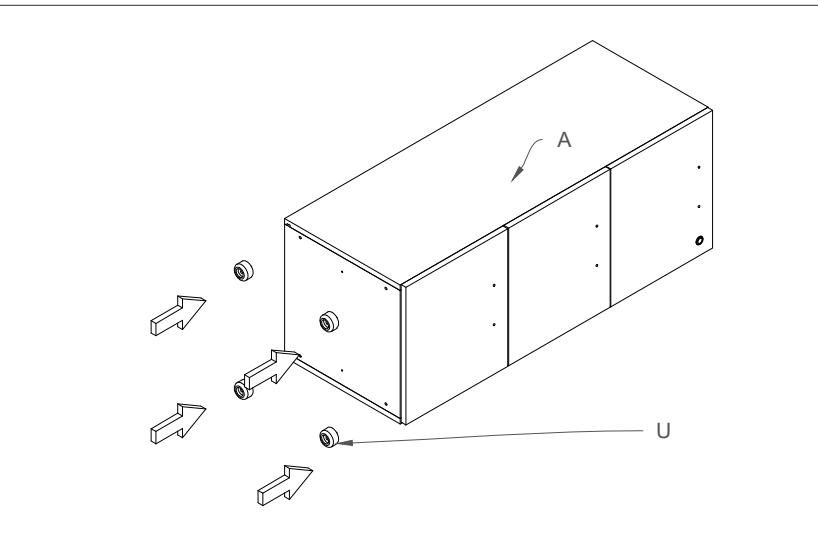

Fig.1 Inserimento del top (B) nel classificatore (A) tramite i bulloni (V).  
Fig.1 Insert the finished top (B) in the filing cabinet (A) by means of the bolts (V)



1) Posizionare il classificatore (A) su un fianco e inserire i piedini (U).

1) Position the filing cabinet (A) on one side, insert the feet (U)



2) Ruotare il classificatore (A) ed estrarre i cassetti.

2) Rotate the filing cabinet (A), extract the drawers

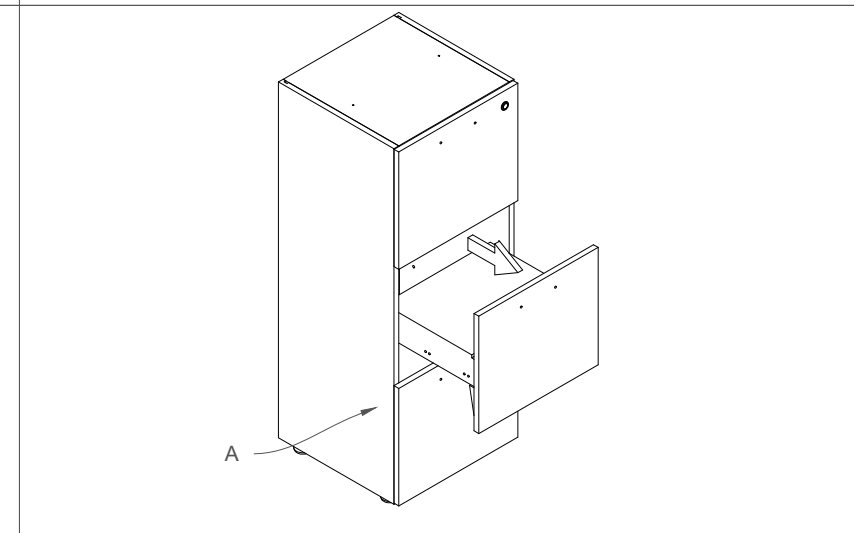

3) Inserire il top (B) nel classificatore (A)

3) Insert the top (B) in the filing cabinet (A)

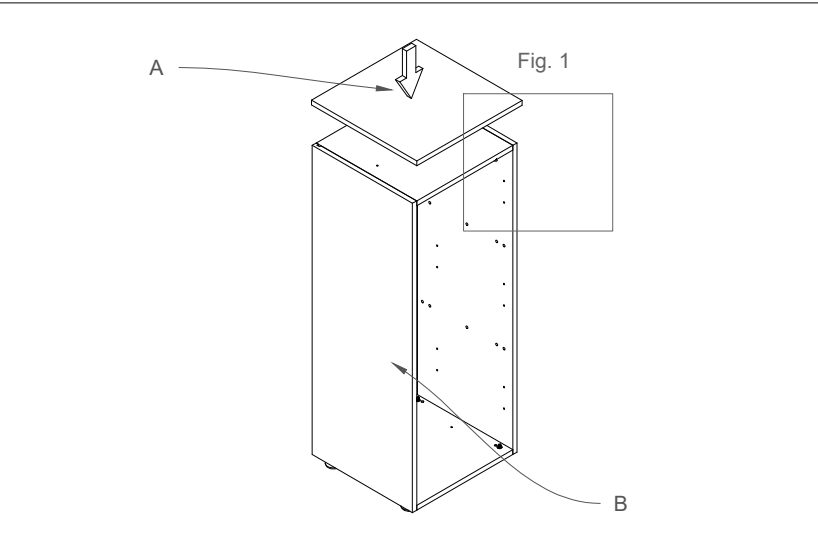

4) Inserire nuovamente i cassetti nel classificatore (A).

4) Insert the drawers in the filing cabinet (A)

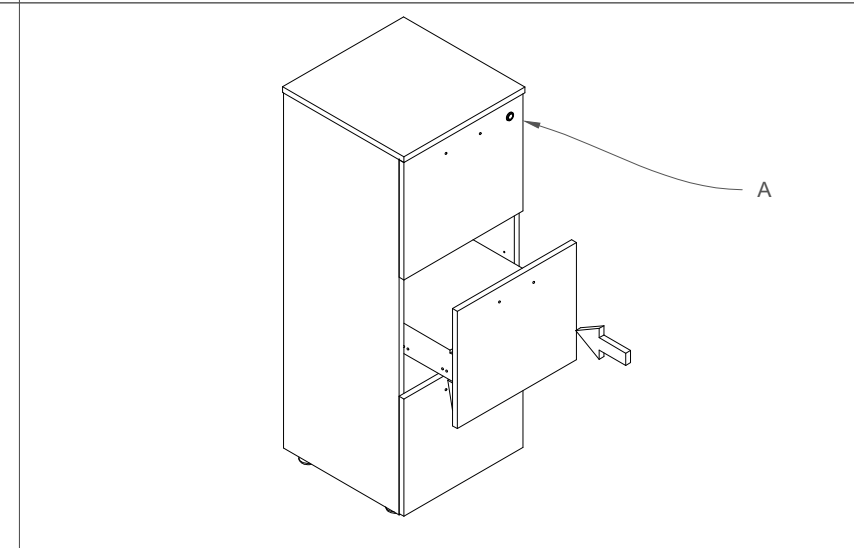

Fig.1 Inserimento delle maniglie (Z) nel classificatore (A) tramite i bulloni (V).  
 Fig.1 Insert the handles (Z) in the filing cabinet (A) by means of the bolts (V)

5) Inserire le maniglie (Z) nel classificatore (A).

5) Insert the handles (Z) in the filing cabinet (A)

