

Ferramenta Hardware	Componenti Components								
Chiave esagonale Hexagonal key	n°1		Coppia fianchi (A) Pair of sides (A)		Base (B) Base (B)		Cappello (C) Top (C)		Retro (D) Back panel (D)
Reggipiani (L) Shelf supports (L)	n°12		Ante vetro alluminio (E) Alluminium glass doors (E)		Ripiani regolabili (F) Adjustable shelves (F)		Top (G) Finished top (G)		Ripiano strutturale (H) Structural shelf (H)
Spina 8x30 (M) Wooden pin 8x30 (M)	n°18								
Tirante 7x33.5 (N) Tie-rod 7x33.5 (N)	n°14		Bullone 4x12 (V) Bolt 4x12 (V)	n°4					
Bariotto14x14 (O) Barrel 14x14 (O)	n°8		Maniglie (Z) Handles (Z)	n°2					
Grano 8x8 (P) Threaded screw 8x8 (P)	n°8		Bariotto14x17.5 (X) Barrel 14x17.5 (X)	n°4					
Basetta (Q) Hinge base (Q)	n°8		Grano 8x12 (Y) Threaded screw 8x12 (Y)	n°4					
Viti 4x30 (R) Screws 4x30 (R)	n°4								
Cerniere (S) Hinge (S)	n°8								
Serratura (T) Lock (T)	n°1								
Piedino (U) Foot (U)	n°4								

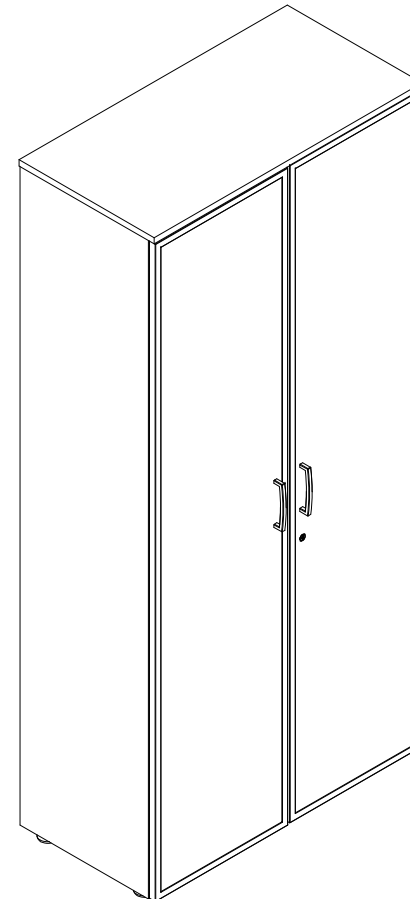
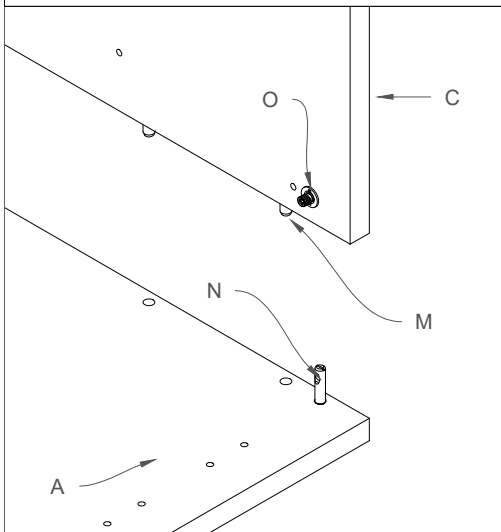
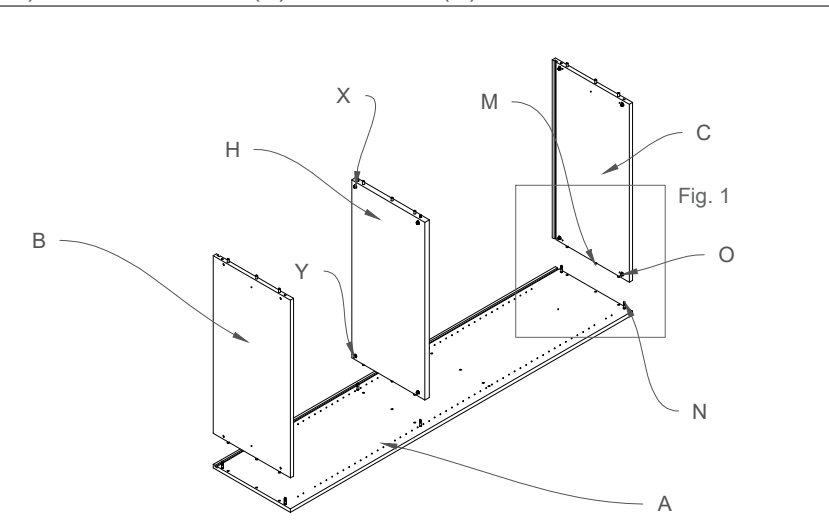

Fig.1 Unire il cappello (C) con il fianco (A) tramite barilotti(O) tiranti (N) e spine (M).
 Fig.1 Unite the top (C) to the side (A) by means of the barrels (O), tie-rods (N) and wooden pins (M).



1) Posizionare un fianco (A) sul pavimento, inserendo tramite le spine (M), barilotti (O e X), grani (Y) e i tiranti (N); la base (B), il ripiano strutturale (H) e il cappello (C).
 1) Position one side (A) on the floor, insert the base (B), structural shelf (H) and top (C) by means of the wooden pins (M), barrels (O and X), threaded screws (Y) and tie-rods (N).



2) Inserire il retro (D) nella fresata, effettuata su un fianco (A) e sulla base (B) e cappello (C).
 2) Insert the back panel (D) in the side (A), base (B) and top (C) slots.

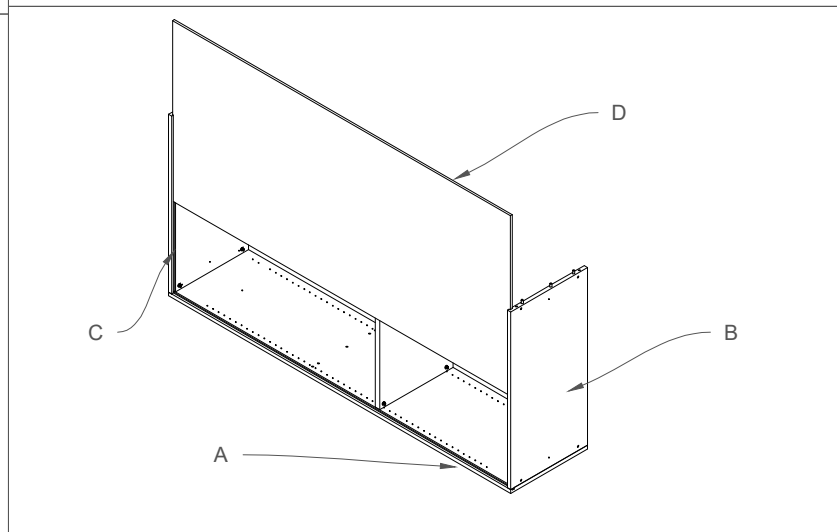
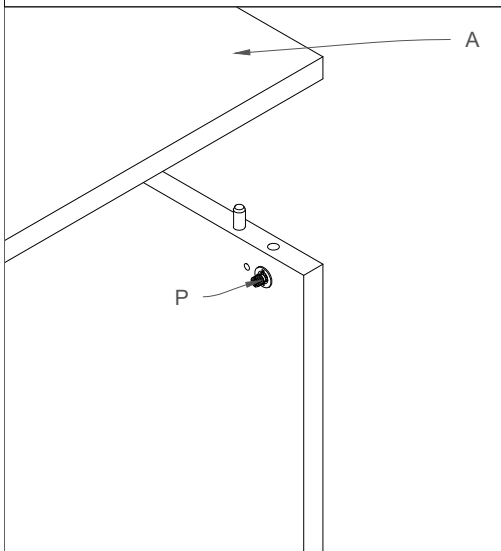
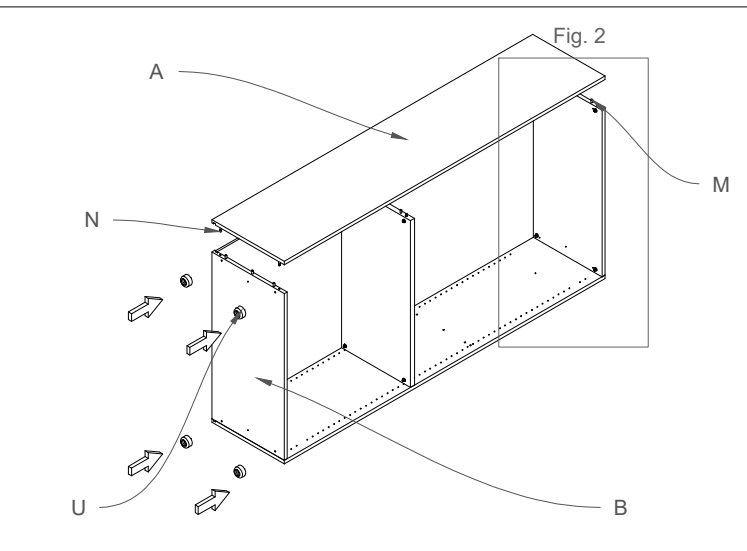

Fig.2 Inserire il fianco (A) e serrare i grani (P).
 Fig.2 Insert the side (A) and tighten the threaded screws (P).



3) Inserire il secondo fianco (A) tramite spine (M) e tiranti (N) e inserire i piedini (U) nella base (B).
 3) Insert the second side (A) by means of the wooden pins (M) and tie-rods (N), insert the feet (U) in the base (B).



4) Ruotare il cabinet ed inserire i ripiani mobili (F) negli appositi reggipiani (L).
 4) Rotate the cabinet and insert the adjustable shelves (F) in the appropriate shelf supports (L).

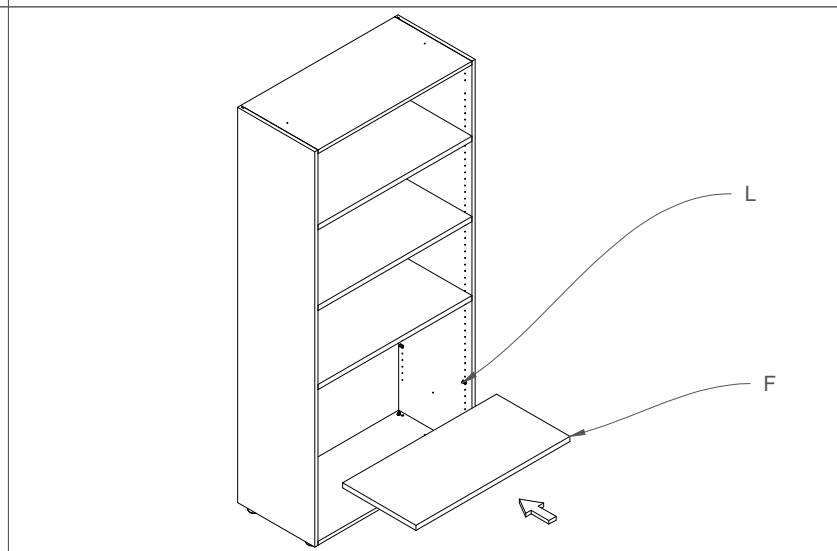
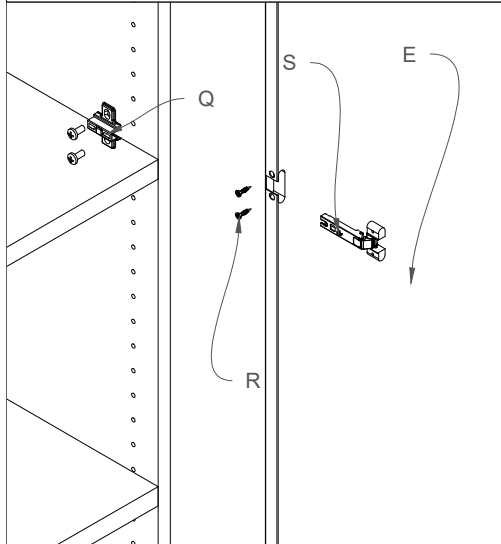

Fig.1 Inserire le cerniere (S) nell'ante (E) tramite le viti (R) e unirle con le basette(Q).

Fig.1 Insert the hinges (S) in the doors (E) by means of the screws (R) and unite them with the hinge bases (Q).



5) Inserire le cerniere (S) e le basette (Q) in modo tale da unire le ante (E) con la cassa.

5) Insert the hinges (S) and the hinge bases (Q) to unite the doors (E) to the box.

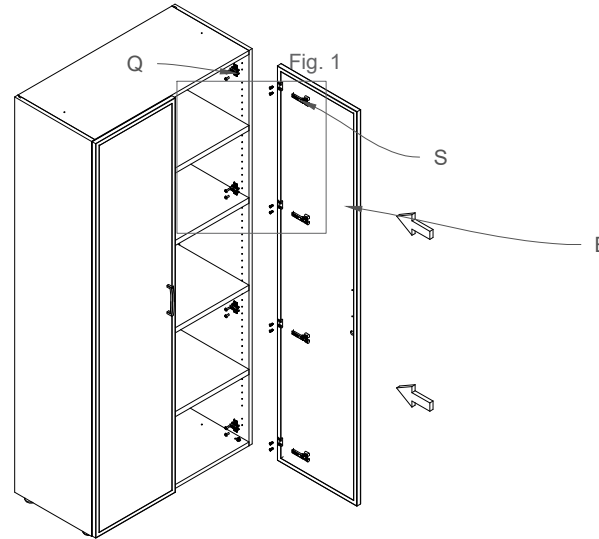

6) Inserire le maniglie (Z) e la serratura (T) nell'anta (E).

6) Insert the handles (Z) and the lock (T) in the door (E).

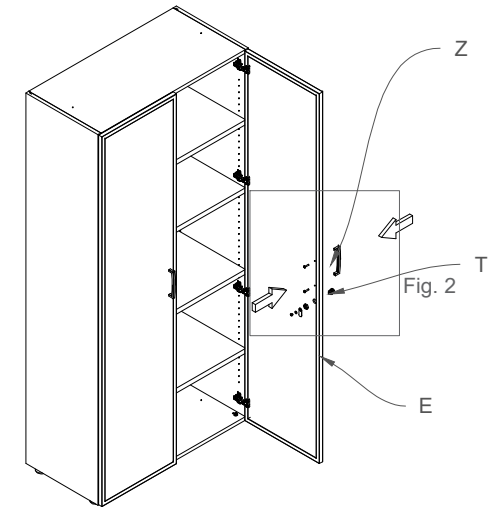
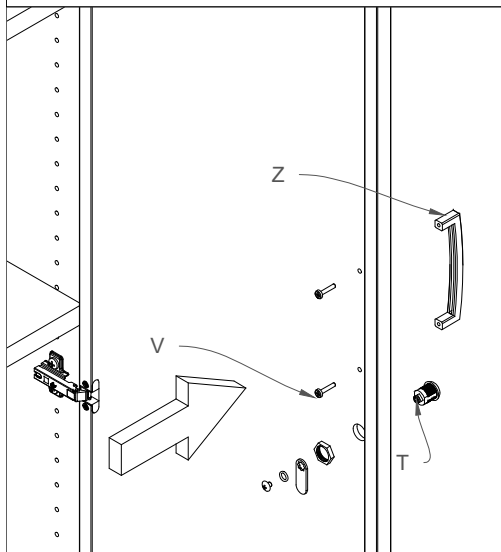

Fig.2 Inserire la maniglia (Z) tramite i bulloni (V) e la serratura (T).

Fig.2 Insert the handle (Z) by means of the bolts (V) and the lock (T).



7) Posizionare il top (G) sul cappello (C).

7) Position the finished top (G) above the top (C).

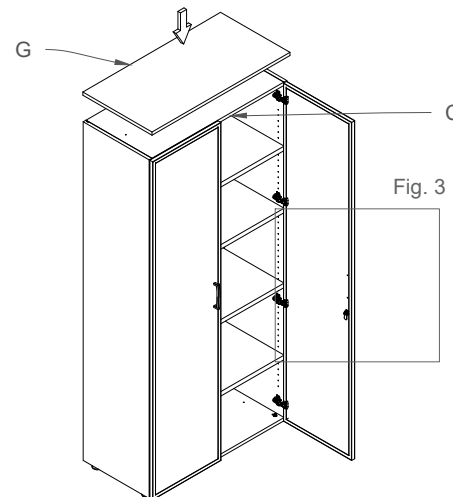

Fig.3 Inserire le viti (I) attraverso le preforature del cappello (C) e forare finché non si aggancia il top (G).

Fig.3 Insert the screws (I) in function to the pre-drilled holes in the top (C) and perforate until the finished top is fastened (G).

