









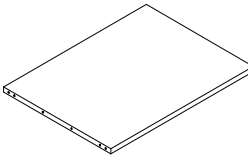

Ferramenta Hardware	Componenti Components									
Chiave esagonale Hexagonal key	n°1			Piano (A) Top (A)		Gamba (B) Leg (B)		Elemento 1 (C) Element 1 (C)		Trave (D) Crossbar (D)
Tirante 7x33.5 (Q) Tie-rod 7x33.5 (Q)	n°8			Elemento di giunzione (E) Junction element (E)		Fianchi (F) Sides (F)		Frontale (G) Frontal panel (G)		Prolunghe per travi (H) Crossbar extensions (H)
Bariotto 14x14 (R) Barrel 14x14 (R)	n°8									
Grano 8x8 (S) Threaded screw 8x8 (S)	n°8									
Spine 8x30 (T) Wooden pin 8x30 (T)	n°14									
Bullone 6x20 (U) Bolt 6x20 (U)	n°8									
Bullone 8x25 (V) Bolt 8x25 (V)	n°4									
Piedini diam. 35 (Z) Feet diam. 35 (Z)	n°2									

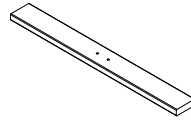
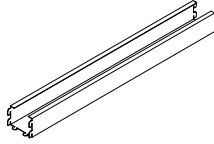
Fig.1 Fissaggio della gamba (B) nell'elemento 1 (C) tramite i bulloni (U).
 Fig.1 Fasten the leg (B) in element 1 (C) by means of the bolts (U).

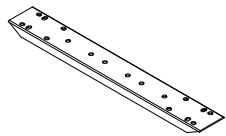
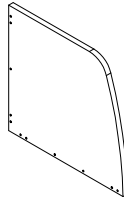
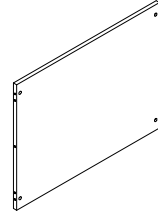
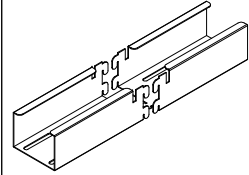
1) Inserire i piedini (Z) nell'elemento 1 (C).
 1) Insert the feet (Z) in element 1 (C).

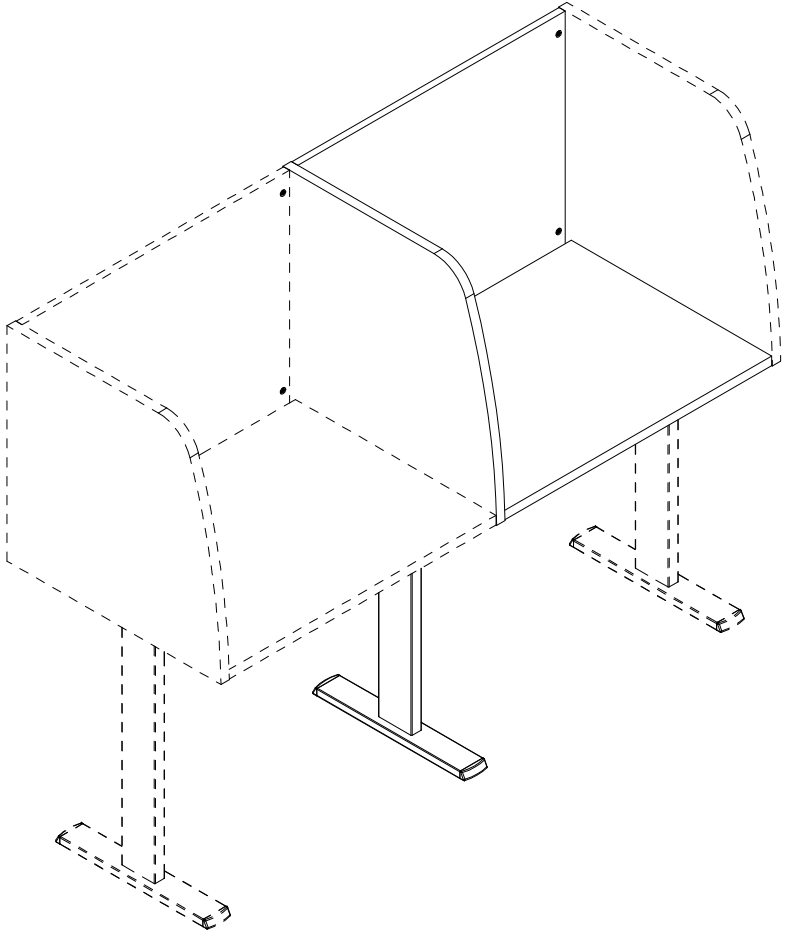
2) Inserire la gamba (B) nell'elemento 1 (C).
 2) Insert the leg (B) in element 1 (C).

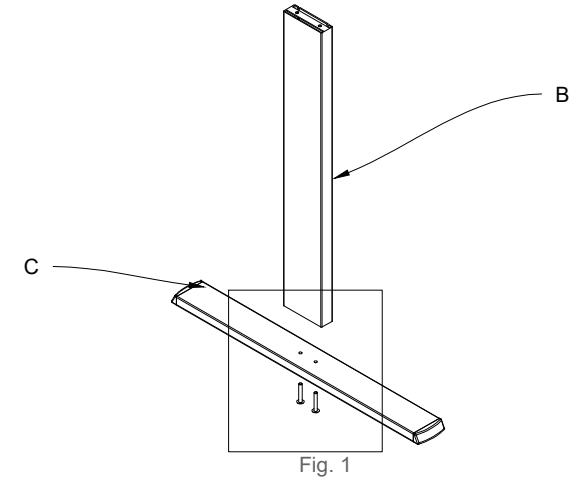
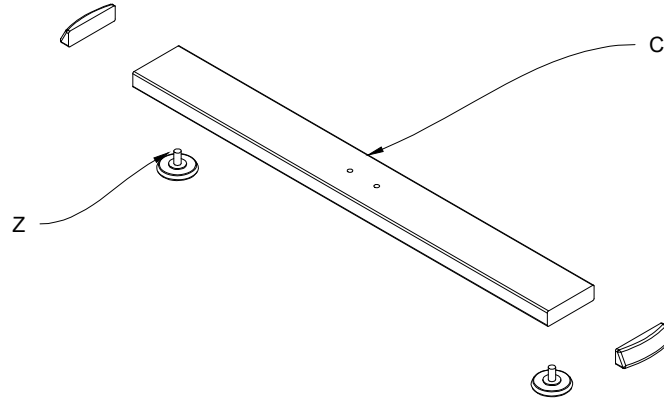
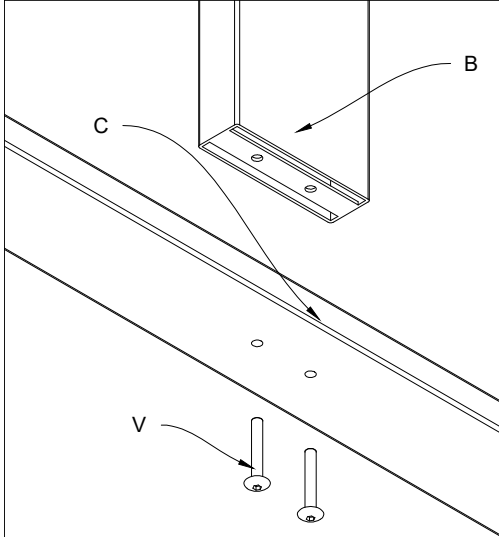

Fig.2 Fissaggio della struttura metallica al piano (A) tramite i bulloni (U).
 Fig.2 Fasten the metallic structure to the top (A) by means of the bolts (U)

3) Unire la gamba condivisa (B) con la prolunga (H) e la trave (D) ad incastro e l'elemento di giunzione (E) tramite i bulloni (V).
 3) Wedge in the intermediate leg (B) with the extension (H), crossbar (D) and junction element (E) by means of the bolts (V)

4) Unire il piano, il frontale e il fianco del call autonomo tramite le spine (T) e i tiranti.
 4) Unite the top, frontal panel and side of the independent Call by means of the wooden pins (T) and tie-rods.

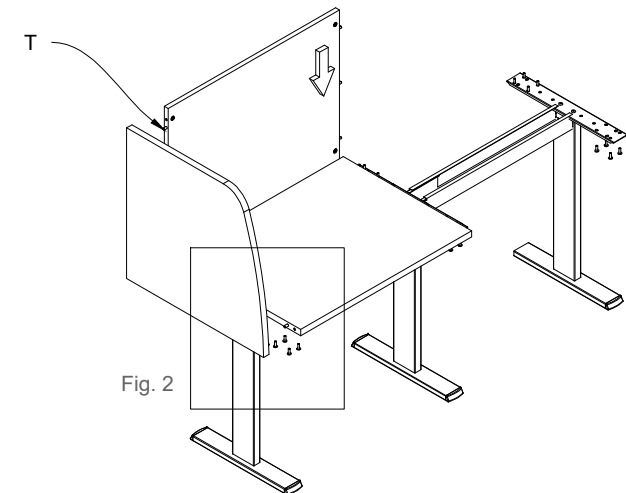
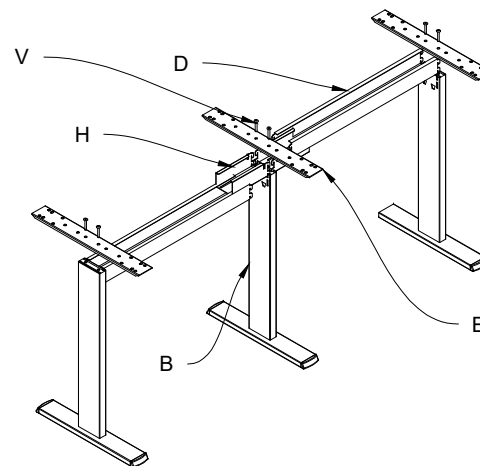
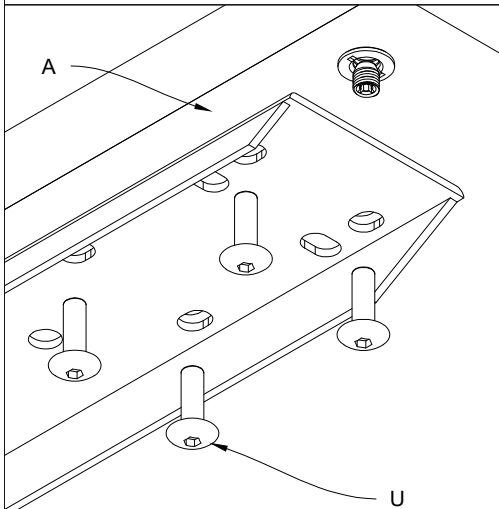
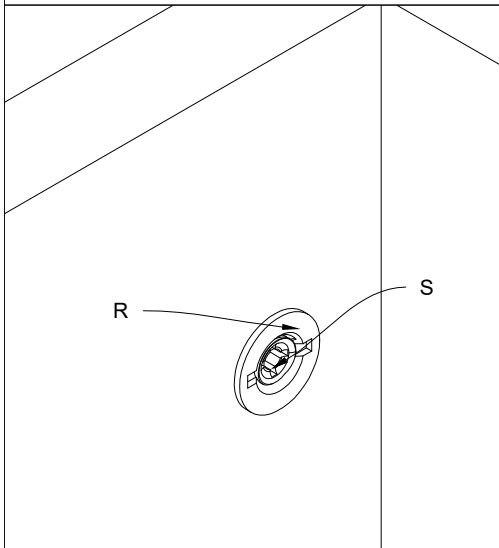

Fig.1 Serraggio dei grani (S) nei barilotti (R).

Fig.1 Tighten the threaded screws (S) in the barrels (R)



5) Inserire il fianco intermedio (F) tramite i tiranti (Q) e le spine (T) nel piano e nel frontale del call autonomo.

5) Insert the intermediate side (F) by means of the tie-rods (Q) and wooden pins (T) in the top and frontal panel of the independent Call

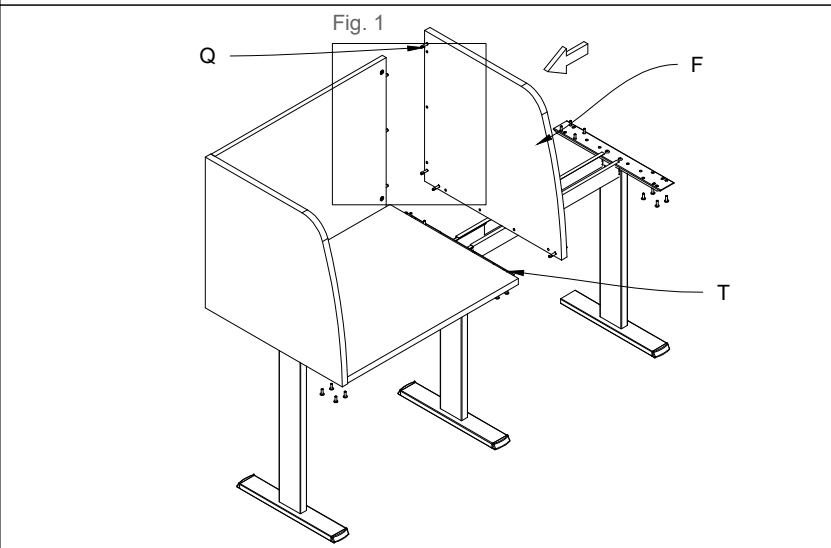

6) Inserire il piano (A), il frontale (G) e il fianco finale del call autonomo nel fianco intermedio (F) tramite le spine (T) e i tiranti (Q)

6) Insert the top (A), frontal panel (G) and side of the independent Call in the intermediate side (F) by means of the wooden pins (T) and tie-rods (Q)

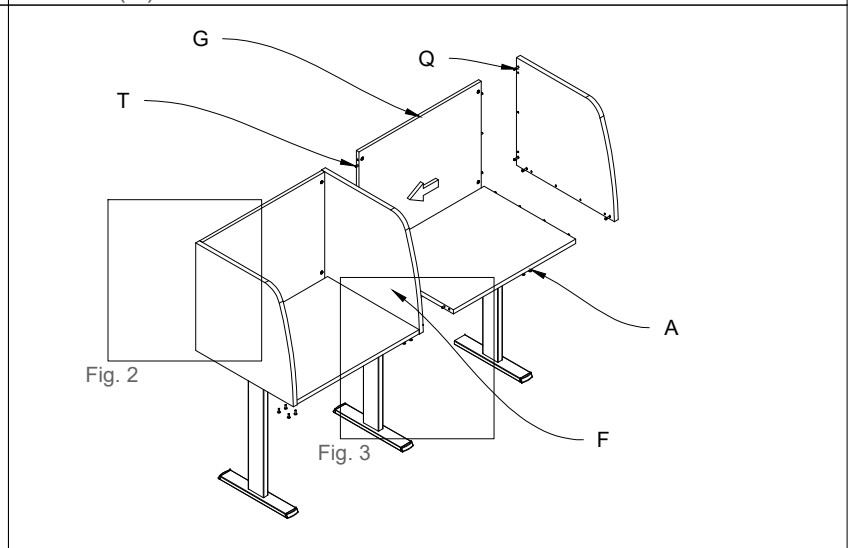

Fig.2 Serraggio dei grani (S) nei barilotti (R).

Fig.2 Tighten the threaded screws (S) in the barrels (R)

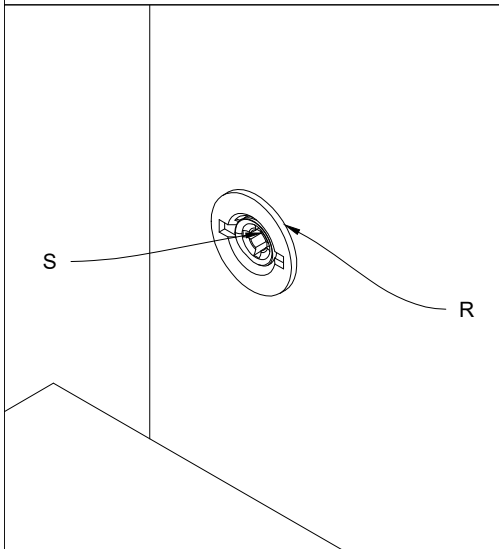

Fig.3 Serrare la struttura metallica con tutti i piani (A) con i bulloni (U)

Fig.3 Tighten the metallic structure to the tops (A) by means of the bolts (U)

