











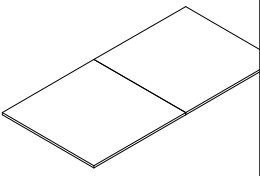
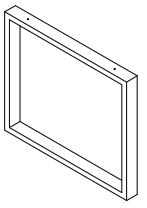
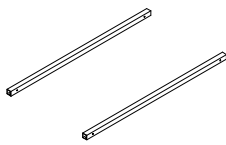
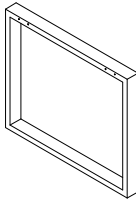

Ferramenta Hardware	Componenti Components		Piano (A) Top (A)	Gambe (B) Legs (B)	Travi (C) Crossbars (C)	Gamba condivisa (D) Intermediate leg (D)
Chiave esagonale Hexagonal key	n°1					
Distanziale composto (M) Compound spacer (M)	n°2					
Distanziale (N) Spacer (N)	n°4					
Paracolpo (O) Strut (O)	n°8					
Piedini diam. 35 (P) Feet diam. 35 (P)	n°6					
Rondella sp.16 (Q) Washer sp.16 (Q)	n°8					
Dado 6 MA (S) Nut 6 MA (S)	n°8					
Bullone 6x16 (T) Bolt 6x16 (T)	n°8					
Bullone 6x20 (U) Bolt 6x20 (U)	n°48					
Bullone 6x45 (V) Bolt 6x45 (V)	n°8					
Bullone 6x60 (Z) Bolt 6x60 (Z)	n°4					

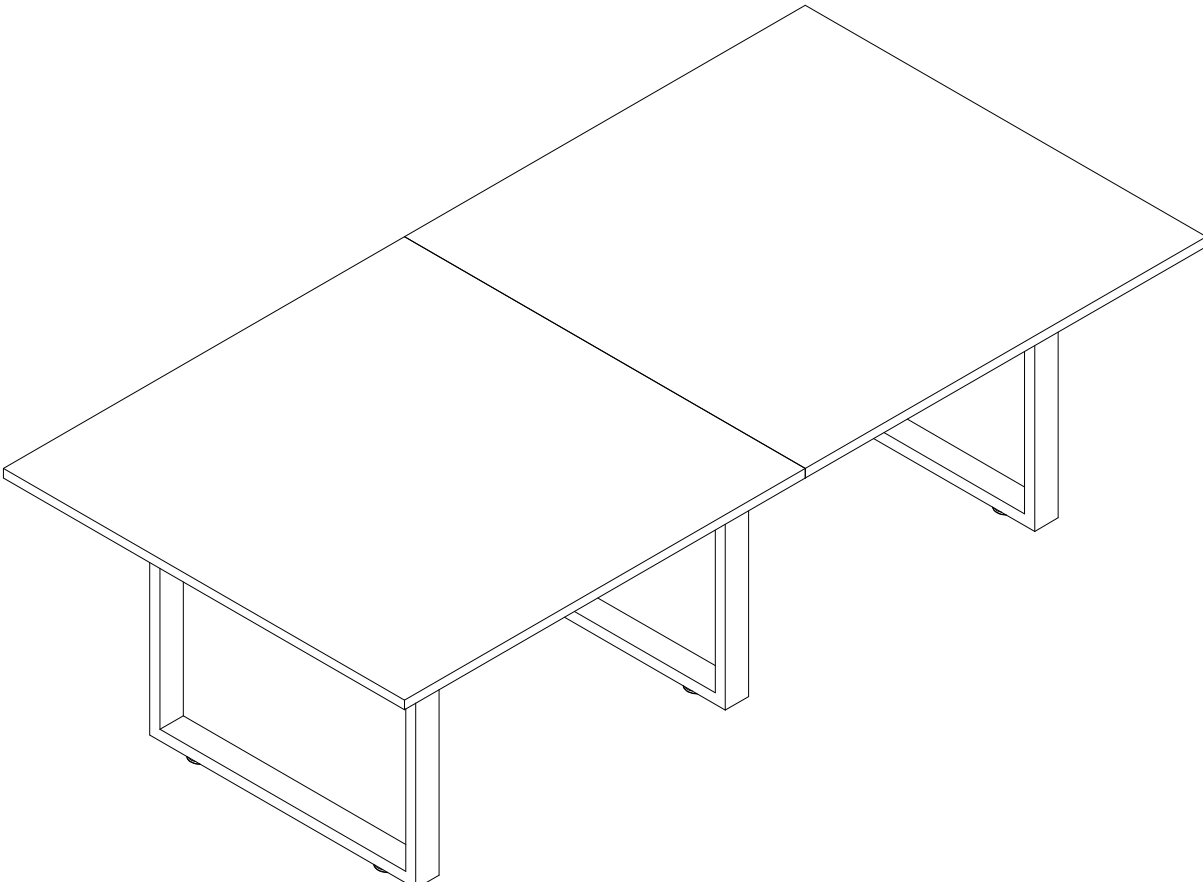
Fig.1 Fissare i bulloni (U) nei distanziali (M) della gamba (D).
 Fig.1 Fasten the bolts (U) in the spacers (M) of the leg (D).

1) Posizionare i distanziali (N) e i piedini (P), nella gamba (D).
 1) Position the spacers (N) and feet (P) in the leg (D).

2) Posizionare i distanziali (N), nella gamba (B) tramite i bulloni (U).
 2) Position the spacers (N) in the leg (B) by means of the bolts (U).

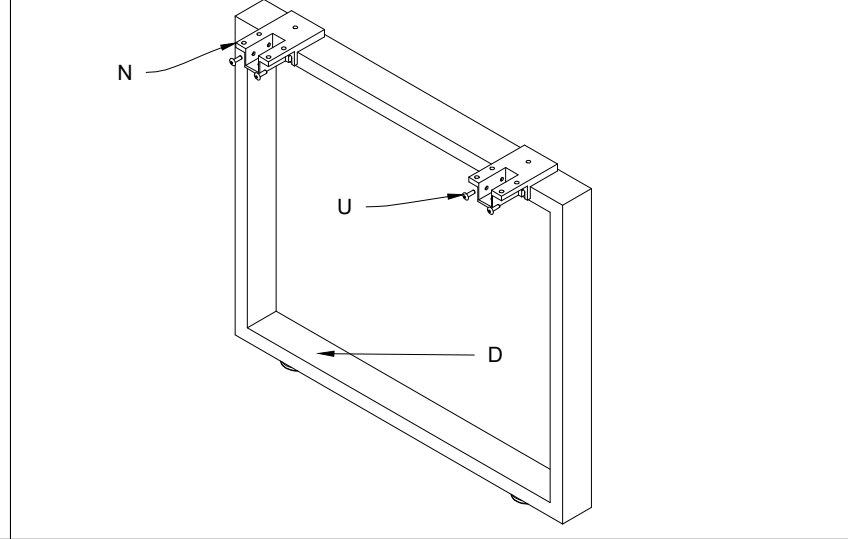
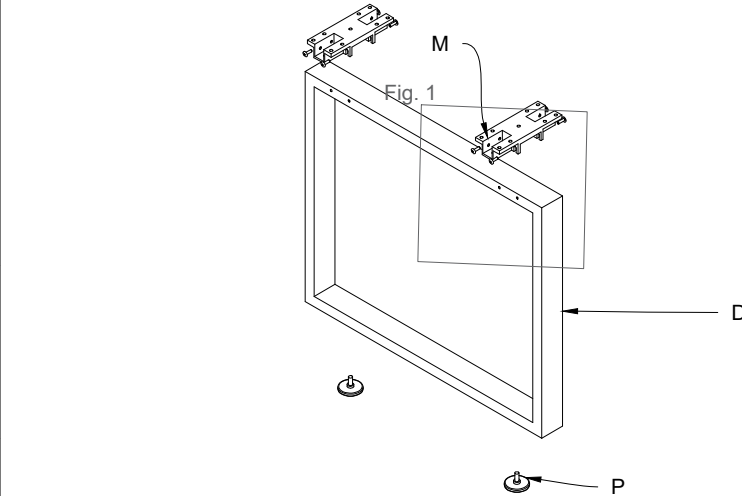
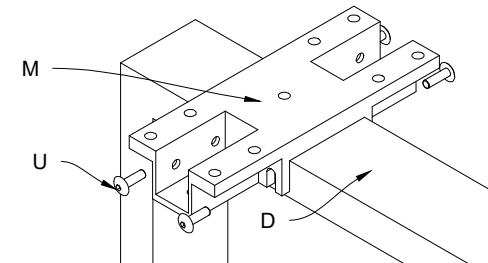
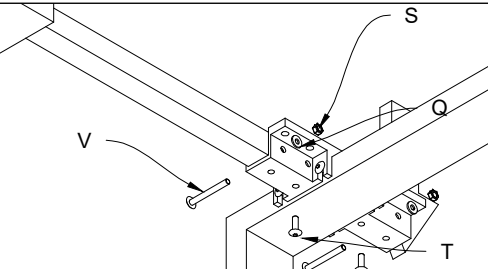

Fig.2 Fissare i bulloni (V e T) nei distanziali (N) con un dado (S) e rondelle (Q), nella struttura.
 Fig.2 Fasten the bolts (V and T) in the spacers (N) by means of the nut (S) and washers (Q) in the structure.



2) Posizionare le travi (C) sulle gambe (B e D) ed inserire i paracolpi (O).
 2) Position the crossbars (C) on the legs (B and D), insert the struts (O).

3) Posizionare il piano (A) sopra la struttura.
 3) Position the top (A) on top of the structure.

Fig.3 Fissare i bulloni (U e Z) nei distanziali con il piano e la struttura.
 Fig.3 Fasten the bolts (U and Z) to the spacers in the top and structure.

