

Schema di montaggio Assembly diagram







Ferramenta Hardware	Componenti Components	Piano (A) Top (A)		Fianco (B) Side (B)		Frontale (C) Frontal panel (C)		
Piedini diam. 35 (S) 	Feet diam. 35 (S) n°4							
Bariotto 14x14 (T) 	Barrel 14x14 (T) n°8							
Grano 8x8 (U) 	Threaded screw 8x8 (U) n°8							
Spina 8x30 (V) 	Wooden pin 8x30 (V) n°12							
Tirante 7x33.5 (Z) 	Tie-rod 7x33.5 (Z) n°8							
								

Fig.1 Serrare i grani (U) nei barilotti (T)

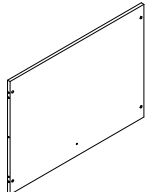
Fig.1 Tighten the threaded screws (U) in the barrels (T)

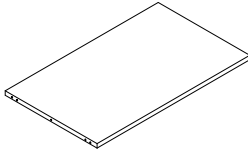

1) Posizionare i tiranti (Z) e i piedini (S) in un fianco (B)

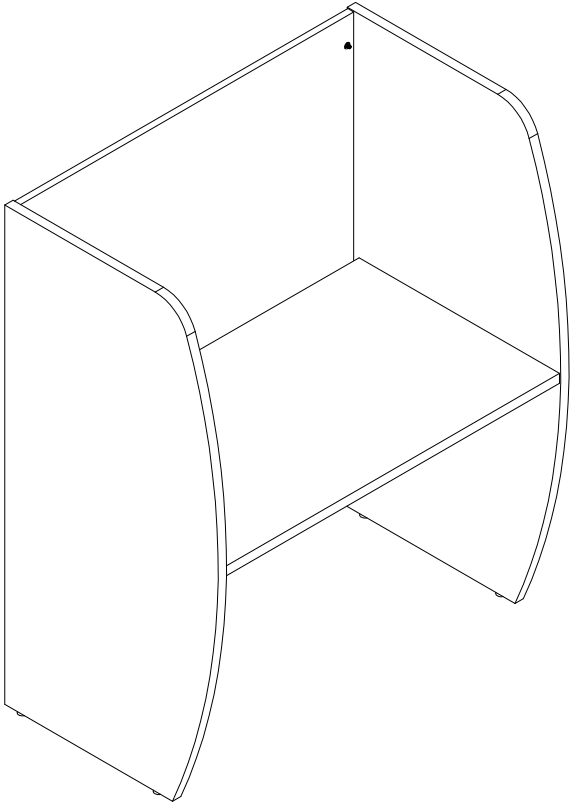
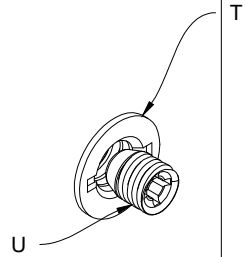
1) Position the tie-rods (Z) and feet (S) in the side (B)

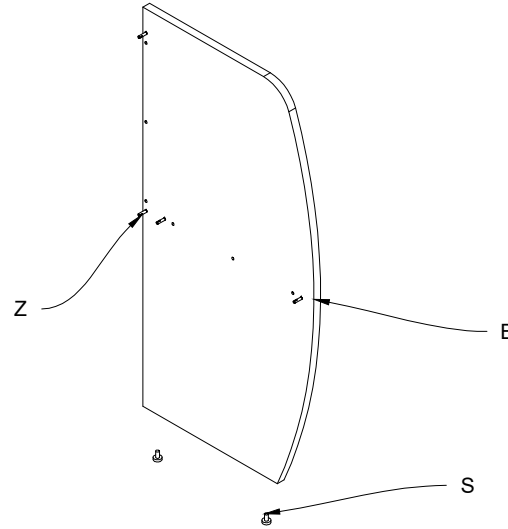

2) Inserire il piano (A) nel fianco (B) tramite i tiranti (Z) e spine (V)

2) Insert the top (A) in the side (B) by means of the tie-rods (Z) and wooden pins (V)

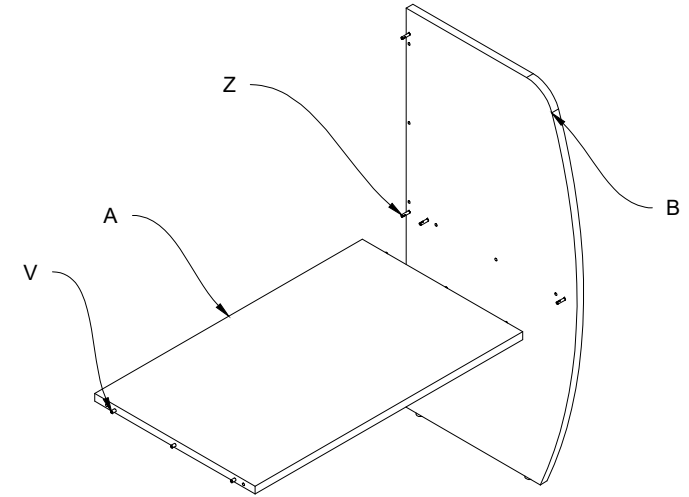
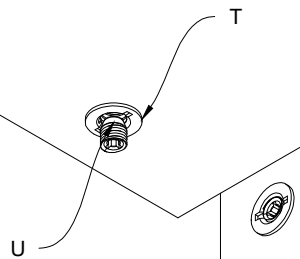

Fig.2 Serrare i grani (U) nei barilotti (T)

Fig.2 Tighten the threaded screws (U) in the barrels (T)



3) Inserire il frontale (C) nel fianco (B) tramite i tiranti (Z) e spine (V).

3) Insert the frontal panel (C) in the side (B) by means of the tie-rods (Z) and wooden pins (V)

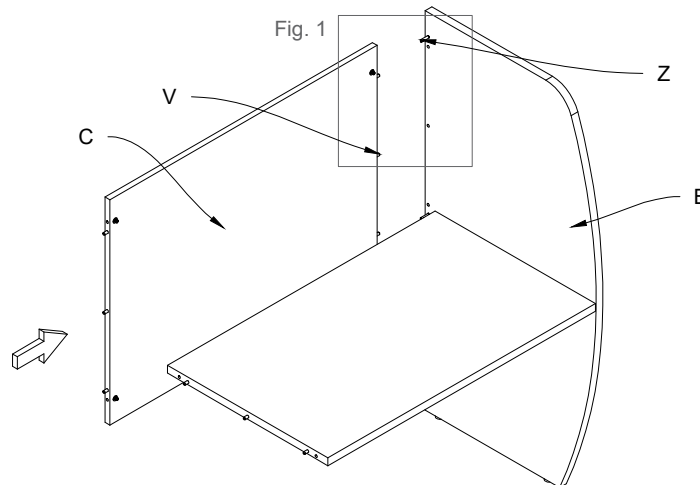

4) Inserire il secondo fianco (B) nel piano (A) e nel frontale (C) tramite i tiranti e le spine (V).

4) Insert the second side (B) in the top (A) and frontal panel (C) by means of the tie-rods (Z) and wooden pins (V)

