



Rev. **00**
 Data Date
 04/11/2020

Emissione Issuance
 Approvazione Approval

Schema di montaggio Assembly diagram

25-30 PA.0157 DX-SX 160x80x73
 25-30 PA.0158 DX-SX 180x80x73
 25-30 PA.0159 DX-SX 200x80x73











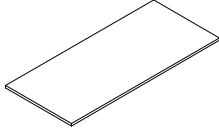
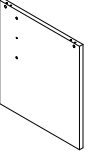
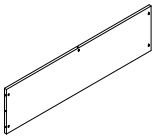
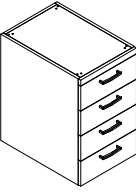

Ferramenta Hardware	Componenti Components		Piano (A) Top (A)		Fianco (B) Side (B)		Traversa (C) Cross panel (C)		Cassettiera (D) Chest of drawers(D)
Spine in legno 8x50 (M) 	Wooden pin 8x50 (M) n°2								
Tirante 7x53.5 (N) 	Tie-rod 7x53.5 (N) n°3								
Distanziale (O) 	Spacer (O) n°3								
Spine in legno 8x30 (P) 	Wooden pin 8x30 (P) n°2	Chiave esagonale 	Hexagonal key n°1						
Tirante 7x33.5 (Q) 	Tie-rod 7x33.5 (Q) n°4								
Grano 8x8 (R) 	Threaded screw 8x8 (R) n°7								
Barilotto 14x14 (S) 	Barrel 14x14 (S) n°7								
Bullone 4x25 (T) 	Bolt 4x25 (T) n°8								
Maniglia (U) 	Handle (U) n°4								
Bullone da 6x28 (V) 	Bolt 6x28 (V) n°4								
Piedini regolabili diam.=35 (Z) 	Adjustable feet diam.=35 (Z) n°6								

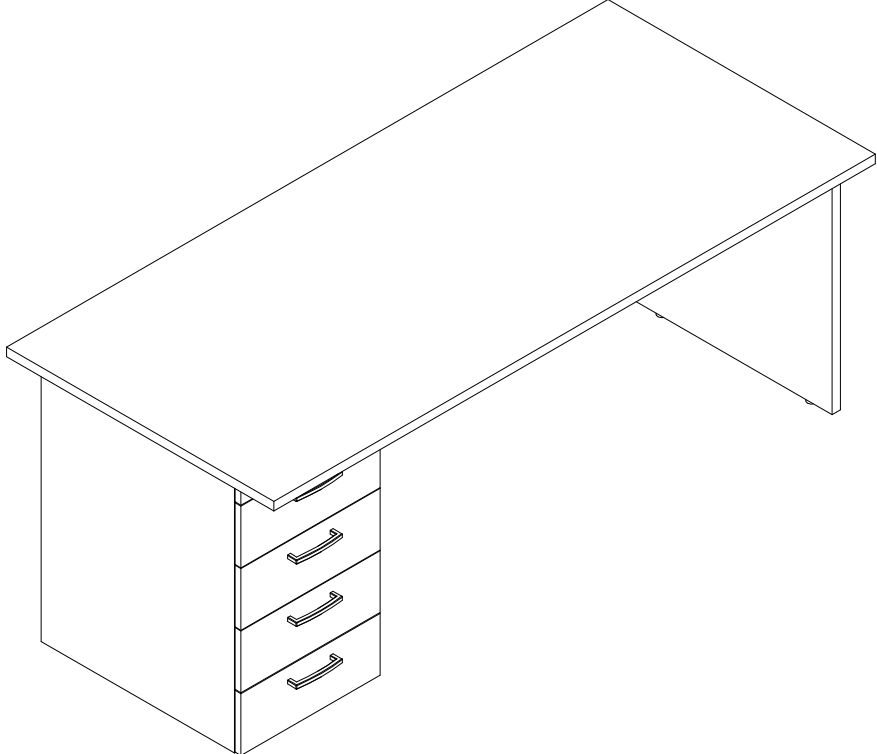
Fig.1 Posizionare i bulloni (T) per fissare le maniglie (U)
Fig.1 Position the bolts (T) to fasten the handles (U)

1) Inserire i piedini (Z) nella cassetiera (D).
1) Insert the feet (Z) in the chest of drawers (D)

2) Inserire le maniglie (U) nella cassetiera (D) tramite i bulloni (T).
2) Insert the handles (U) in the chest of drawers (D) by means of the bolts (T)

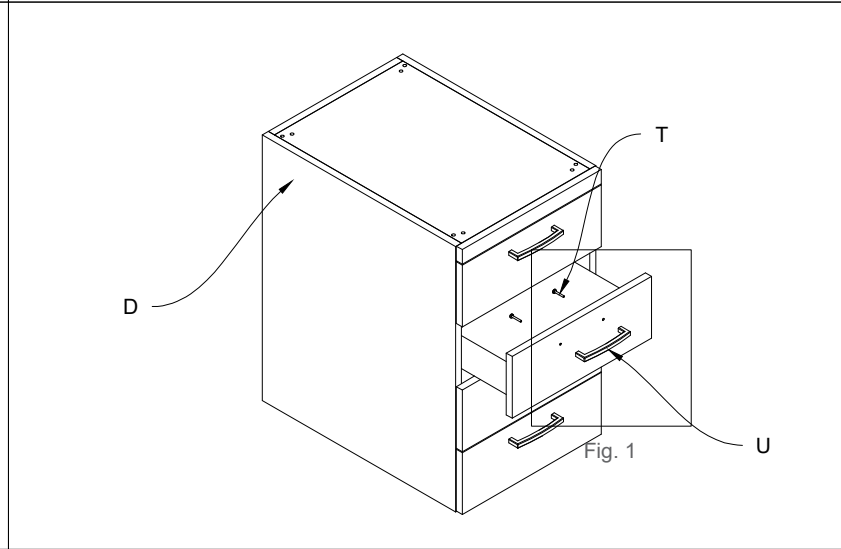
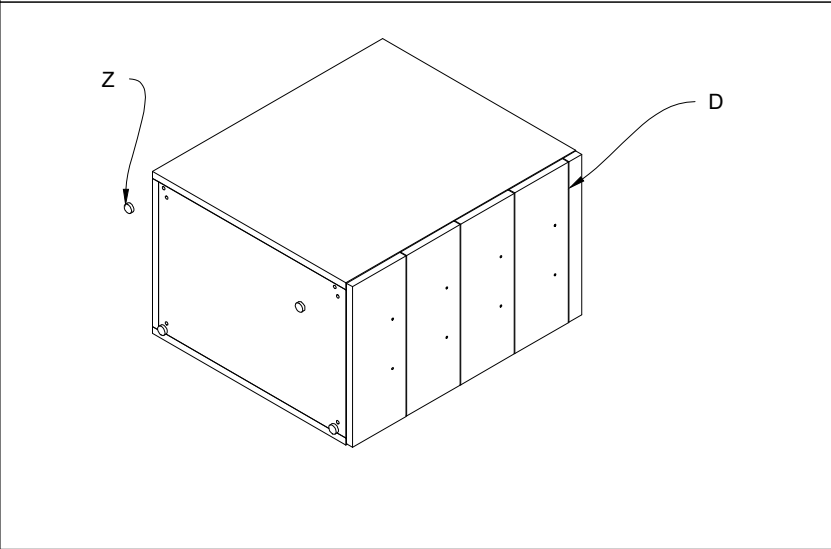
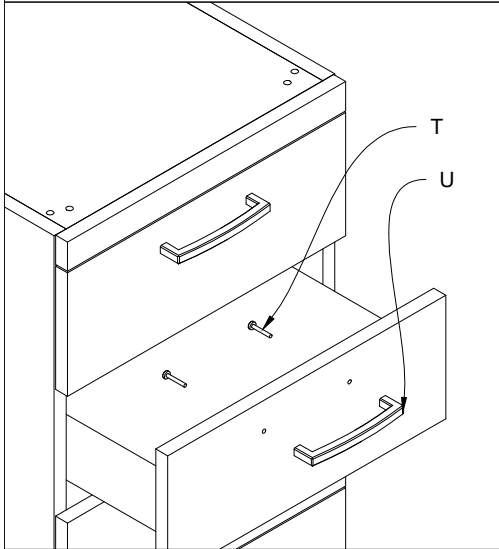

Fig.2 Inserire le spine (M), tiranti (Q), distanziali (O) e i barilotti (S) nei fianchi (B).
Fig.2 Insert the wooden pins (M), tie-rods (Q), spacers (O) and barrels (S) in the sides (B)

3) Inserire le spine (M), tiranti (Q), distanziali (O), barilotti (S) e i piedini (Z) nel fianco (B).
3) Insert the wooden pins (M), tie-rods (Q), spacers (O), barrels (S) and feet (Z) in the side (B)

4) Unire la traversa (D) al fianco (B) tramite le spine (P), tiranti (Q) ,barilotti (S) ed inserire il distanziale (O).
4) Unite the cross panel (D) to the side (B) by means of the wooden pins (P), tie-rods (Q) and barrels (S), insert the spacers (O)

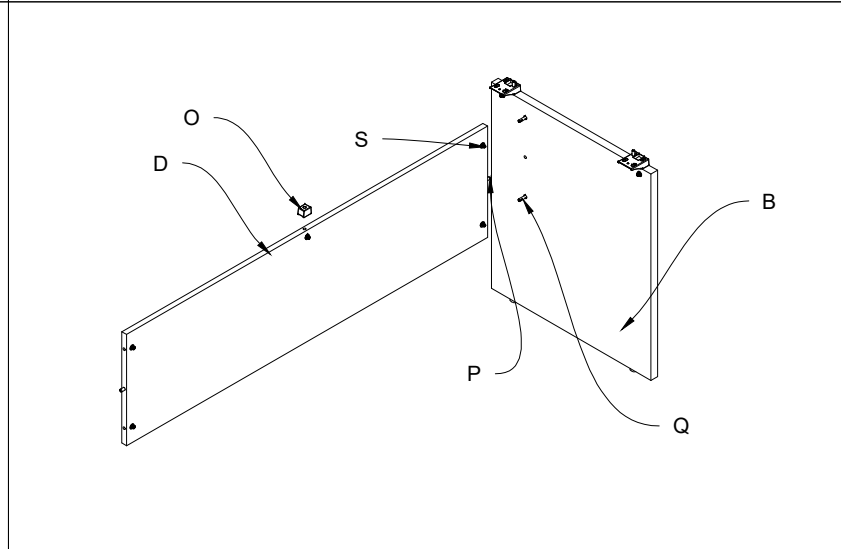
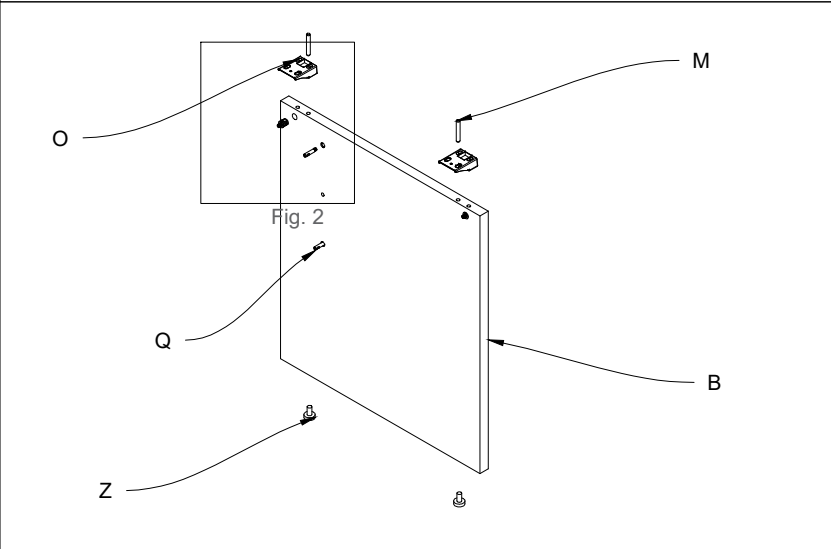
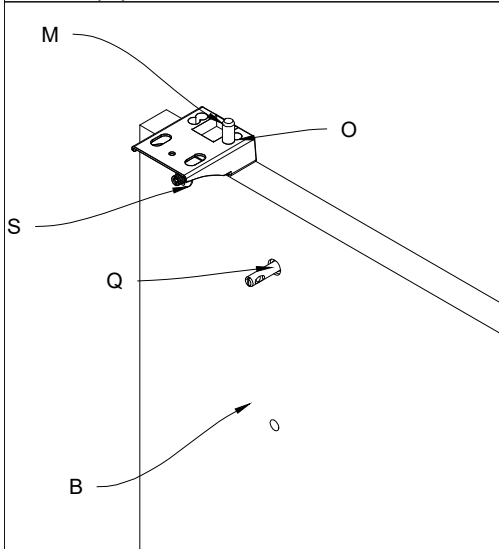
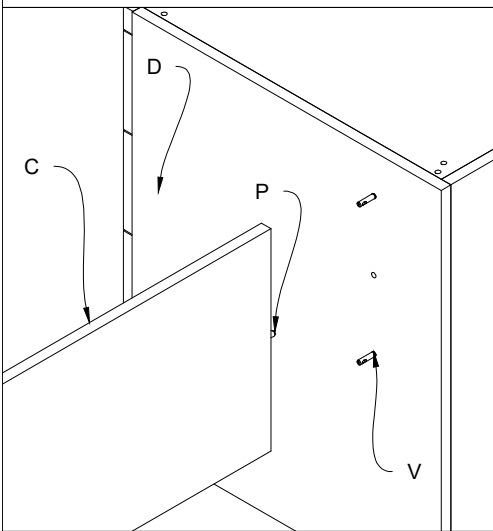
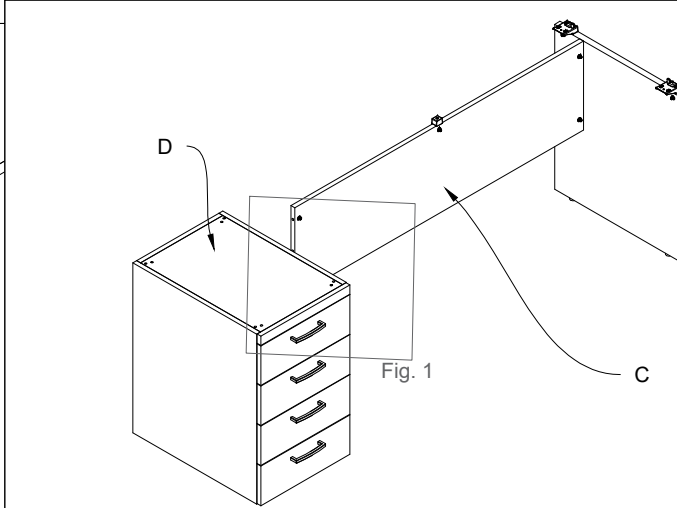

Fig.1 Unire le traversa (C) con la cassetiera (D) tramite le spine (P) e inserire i bulloni (V).
Fig.1 Unite the cross panel (C) to the chest of drawers (D) by means of the wooden pins (P), insert the bolts (V)



5) Unire la traversa (C) con la cassetiera (D) .
5) Unite the cross panel (C) to the chest of drawers (D)



6) Posizionare il piano (A) sopra la struttura.
6) Position the top (A) above the structure

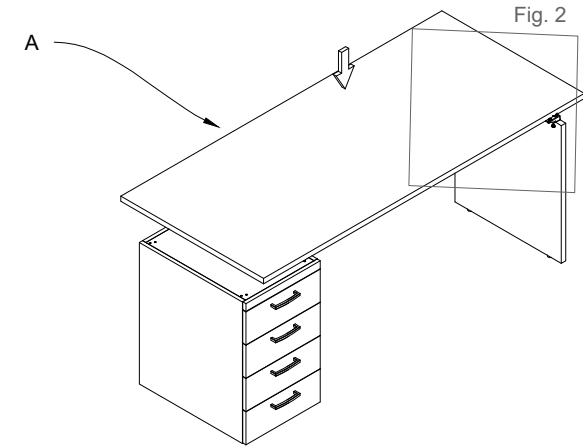

Fig.2 Unire il piano (A) con la struttura tramite i tiranti (N) e serrare i grani (R).
Fig.2 Unite the top (A) to the structure by means of the tie-rods (N) and tighten the threaded screws (R)

